

SKF spherical plain bearings and rod ends



® SKF is a registered trademark of the SKF Group.

© SKF Group 2011

The contents of this catalogue are the copyright of the publisher and may not be reproduced (even extracts) unless prior written permission is granted. Every care has been taken to ensure the accuracy of the information contained in this catalogue but no liability can be accepted for any loss or damage whether direct, indirect or consequential arising out of the use of the information contained herein.

PUB BU/P1 06116/1 EN · September 2011

This publication supersedes publication 4407/II E.

Principles of selection and application	25	1
Radial spherical plain bearings requiring maintenance ..	99	2
Maintenance-free radial spherical plain bearings	125	3
Angular contact spherical plain bearings	151	4
Thrust spherical plain bearings	159	5
Rod ends requiring maintenance	167	6
Maintenance-free rod ends	189	7
Other SKF plain bearings and special solutions	207	8
Product index	213	9

Contents

Foreword	5
Unit conversions	7
SKF – the knowledge engineering company	8
General product information	13
1 Principles of selection and application	25
Selection of bearing type	27
Selection of bearing size	38
Friction	69
Design of bearing arrangements	70
Lubrication	84
Relubrication	90
Mounting	92
Dismounting	96
2 Radial spherical plain bearings requiring maintenance	99
Product tables	
2.1 Radial spherical plain bearings, steel/steel, metric sizes	104
2.2 Radial spherical plain bearings, steel/steel, inch sizes	110
2.3 Radial spherical plain bearings with an extended inner ring, steel/steel, metric sizes ..	116
2.4 Radial spherical plain bearings with an extended inner ring, steel/steel, inch sizes ...	120
3 Maintenance-free radial spherical plain bearings	125
Product tables	
3.1 Maintenance-free radial spherical plain bearings, steel/PTFE sintered bronze, metric sizes	132
3.2 Maintenance-free radial spherical plain bearings, steel/PTFE fabric, metric sizes.....	134
3.3 Maintenance-free radial spherical plain bearings, steel/PTFE fabric, inch sizes	140
3.4 Maintenance-free radial spherical plain bearings, steel/PTFE FRP, metric sizes	144
4 Angular contact spherical plain bearings	151
Product tables	
4.1 Maintenance-free angular contact spherical plain bearings, steel/PTFE FRP	156
5 Thrust spherical plain bearings	159
Product tables	
5.1 Maintenance-free thrust spherical plain bearings, steel/PTFE FRP	164

6 Rod ends requiring maintenance	167
Product tables	
6.1 Rod ends with a female thread, steel/steel	172
6.2 Rod ends with a female thread, for hydraulic cylinders, steel/steel.....	174
6.3 Rod ends with a male thread, steel/steel	178
6.4 Rod ends with a cylindrical section welding shank, steel/steel	180
6.5 Rod ends with a rectangular section welding shank, steel/steel	182
6.6 Rod ends with a female thread, steel/bronze	184
6.7 Rod ends with a male thread, steel/bronze	186
7 Maintenance-free rod ends.....	189
Product tables	
7.1 Maintenance-free rod ends with a female thread, steel/PTFE sintered bronze	194
7.2 Maintenance-free rod ends with a male thread, steel/PTFE sintered bronze	196
7.3 Maintenance-free rod ends with a female thread, steel/PTFE fabric	198
7.4 Maintenance-free rod ends with a male thread, steel/PTFE fabric	200
7.5 Maintenance-free rod ends with a female thread, steel/PTFE FRP	202
7.6 Maintenance-free rod ends with a male thread, steel/PTFE FRP	204
8 Other SKF products and services	207
9 Product index	213



The SKF brand now stands for more than ever before, and means more to you as a valued customer.

While SKF maintains its leadership as a high-quality bearing manufacturer throughout the world, new dimensions in technical advances, product support and services have evolved SKF into a truly solutions-oriented supplier, creating greater value for customers.

These solutions enable customers to improve productivity, not only with breakthrough application-specific products, but also through leading-edge design simulation tools and consultancy services, plant asset efficiency maintenance programmes, and the industry's most advanced supply management techniques.

The SKF brand still stands for the very best in rolling bearings, but it now stands for much more.

SKF – the knowledge engineering company

Foreword

Many applications require bearings that are suitable for oscillating movements and that can accommodate misalignment. Rolling bearings only partly fulfil these requirements as they are generally designed for continuous rotation and can only accommodate limited misalignment.

Therefore, SKF manufactures spherical plain bearings and rod ends to provide an economical solution to these challenges.

This catalogue presents the current assortment of SKF spherical plain bearings and rod ends.

Structure of the catalogue

The catalogue starts with general product information, followed by nine main chapters, which are marked with numbered blue tabs in the right margin:

- Chapter 1 provides design and application recommendations.
- Chapters 2 to 7 describe the various bearing and rod end types. Each chapter contains descriptions of the products as well as product tables, listing data for selecting a bearing or rod end and designing the bearing arrangement.
- Chapter 8 is an overview about other SKF products and services.
- In chapter 9, all products presented in this catalogue are listed in alphabetical order by designation.

About the data in this catalogue

The data in this catalogue relate to SKF's state-of-the-art technology and production capabilities as of beginning 2010. The data may differ from that shown in earlier catalogues because of revised methods of calculation, redesign or technological developments. For example, the following new information and product data

have been included for radial spherical plain bearings:

- Bearings in the TX series have been added and are available with bore diameters up to 800 mm.
- Bearings in the maintenance-free series are fitted with LS seals as standard.
- Bearings with the sliding material FSA have been replaced by the FBAS design.
- Bearings requiring maintenance are also available with LS seals.
- Part of the inch assortment is also available with LS seals.

SKF reserves the right to make continuing improvements to SKF products with respect to materials, design and manufacturing methods, as well as changes necessitated by technological developments.

The units used in this catalogue are in accordance with ISO (International Organization for Standardization) standard 1000:1992, and SI (Système International d'Unités). Unit conversions are listed in the table on **page 7**.

Other SKF catalogues

The total SKF product portfolio is much broader than just spherical plain bearings and rod ends. Product information is also available via the SKF website at www.skf.com. The *SKF Interactive Engineering Catalogue* provides not only product information, but also online calculation tools, CAD drawings in various formats, and search and selection functions.

The main printed SKF catalogues are:

- General catalogue
- Needle roller bearings
- High-precision bearings
- Y-bearings and Y-bearing units

- Bearing housings
- Slewing bearings
- Linear motion standard range
- SKF Maintenance and Lubrication Products
- Centralized lubrication systems
- Industrial shaft seals
- SKF Power transmission products

For additional information about SKF products and services, contact your local SKF representative or SKF Authorized Distributor.

More advantages

SKF aims to deliver industry-leading, high value products, services and knowledge-engineered solutions. Many of the product's capabilities contribute to the overall value customers receive in making SKF their supplier of choice, such as:

- simplified bearing selection
- short delivery times
- worldwide availability
- commitment to product innovation
- state-of-the-art application solutions
- extensive engineering and technology knowledge in virtually every industry

Unit conversions

Quantity	Unit	Conversion			
Length	inch	1 mm	0,03937 in	1 in	25,40 mm
	foot	1 m	3,281 ft	1 ft	0,3048 m
	yard	1 m	1,094 yd	1 yd	0,9144 m
	mile	1 km	0,6214 mile	1 mile	1,609 km
Area	square inch	1 mm ²	0,00155 sq.in	1 sq.in	645,16 mm ²
	square foot	1 m ²	10,76 sq.ft	1 sq.ft	0,0929 m ²
Volume	cubic inch	1 cm ³	0,061 cub.in	1 cub.in	16,387 cm ³
	cubic foot	1 m ³	35 cub.ft	1 cub.ft	0,02832 m ³
	imperial gallon	1 l	0,22 gallon	1 gallon	4,5461 l
	U.S. gallon	1 l	0,2642 U.S. gallon	1 U.S. gallon	3,7854 l
Velocity, speed	foot per second	1 m/s	3,28 ft/s	1 ft/s	0,30480 m/s
	mile per hour	1 km/h	0,6214 mile/h (mph)	1 mile/h (mph)	1,609 km/h
Mass	ounce	1 g	0,03527 oz	1 oz	28,350 g
	pound	1 kg	2,205 lb	1 lb	0,45359 kg
	short ton	1 tonne	1,1023 short ton	1 short ton	0,90719 tonne
	long ton	1 tonne	0,9842 long ton	1 long ton	1,0161 tonne
Density	pound per cubic inch	1 g/cm ³	0,0361 lb/cub.in	1 lb/cub.in	27,680 g/cm ³
Force	pound-force	1 N	0,225 lbf	1 lbf	4,4482 N
Pressure, stress	pounds per square inch	1 MPa	145 psi	1 psi	6,8948 × 10 ³ Pa
Moment	inch pound-force	1 Nm	8,85 in.lbf	1 in.lbf	0,113 Nm
Power	foot-pound per second	1 W	0,7376 ft lbf/s	1 ft lbf/s	1,3558 W
	horsepower	1 kW	1,36 HP	1 HP	0,736 kW
Temperature	degree	Celsius	$t_C = 0,555 (t_F - 32)$	Fahrenheit	$t_F = 1,8 t_C + 32$

SKF – the knowledge engineering company

From the company that invented the self-aligning ball bearing more than 100 years ago, SKF has evolved into a knowledge engineering company that is able to draw on five technology platforms to create unique solutions for its customers. These platforms include bearings, bearing units and seals, of course, but extend to other areas including: lubricants and lubrication systems, critical for long bearing life in many applications; mechatronics that combine mechanical and electronics knowledge into systems for more effective linear motion and sensorized solutions; and a full range of services, from design and logistics support to condition monitoring and reliability systems.

Though the scope has broadened, SKF continues to maintain the world's leadership in the design, manufacture and marketing of rolling bearings, as well as complementary products such as radial seals. SKF also holds an increasingly important position in the market for linear motion products, high-precision aerospace bearings, machine tool spindles and plant maintenance services.

The SKF Group is globally certified to ISO 14001, the international standard for environmental management, as well as OHSAS 18001, the health and safety management standard. Individual divisions have been approved for quality certification in accordance with ISO 9001 and other customer specific requirements.

With over 100 manufacturing sites worldwide and sales companies in 70 countries, SKF is a truly international corporation. In addition, our 15 000 distributors and dealers around the world, an e-business marketplace, and a global distribution system, put SKF closer to customers to enhance their ability to quickly supply both products and services. In essence, SKF solutions are available wherever and whenever customers need them. Overall, the SKF brand and the corporation are stronger than ever. As the knowledge engineering company, we stand ready to serve you with world-class product competencies, intellectual resources, and the vision to help you succeed.

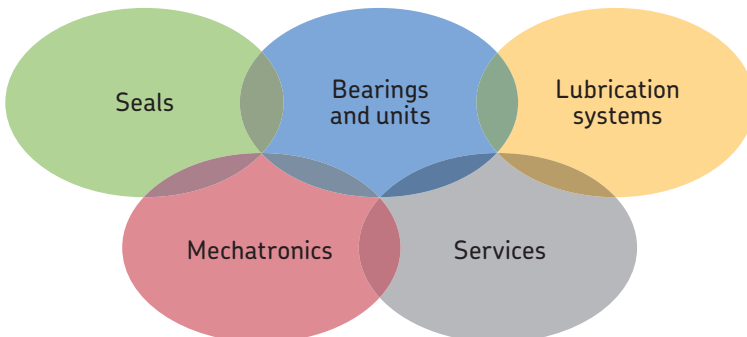



© Airbus – photo: e'm company, H. Goussé

Evolving by-wire technology

SKF has a unique expertise in the fast-growing by-wire technology, from fly-by-wire, to drive-by-wire, to work-by-wire. SKF pioneered practical fly-by-wire technology and is a close working partner with all aerospace industry leaders. As an example, virtually all aircraft of the Airbus design use SKF by-wire systems for cockpit flight control.



SKF is also a leader in automotive by-wire technology, and has partnered with automotive engineers to develop two concept cars, which employ SKF mechatronics for steering and braking. Further by-wire development has led SKF to produce an all-electric forklift truck, which uses mechatronics rather than hydraulics for all controls.



Harnessing wind power

The growing industry of wind-generated electric power provides a source of clean, green electricity. SKF is working closely with global industry leaders to develop efficient and trouble-free turbines, providing a wide range of large, highly specialized bearings and condition monitoring systems to extend equipment life of wind farms located in even the most remote and inhospitable environments.



Working in extreme environments

In frigid winters, especially in northern countries, extreme sub-zero temperatures can cause bearings in railway axleboxes to seize due to lubrication starvation. SKF created a new family of synthetic lubricants formulated to retain their lubrication viscosity even at these extreme temperatures. SKF knowledge enables manufacturers and end user customers to overcome the performance issues resulting from extreme temperatures, whether hot or cold. For example, SKF products are at work in diverse environments such as baking ovens and instant freezing in food processing plants



Developing a cleaner cleaner

The electric motor and its bearings are the heart of many household appliances. SKF works closely with appliance manufacturers to improve their products' performance, cut costs, reduce weight, and reduce energy consumption. A recent example of this cooperation is a new generation of vacuum cleaners with substantially more suction. SKF knowledge in the area of small bearing technology is also applied to manufacturers of power tools and office equipment.



Maintaining a 350 km/h R&D lab

In addition to SKF's renowned research and development facilities in Europe and the United States, Formula One car racing provides a unique environment for SKF to push the limits of bearing technology. For over 60 years, SKF products, engineering and knowledge have helped make Scuderia Ferrari a formidable force in F1 racing. (The average racing Ferrari utilizes around 150 SKF components.) Lessons learned here are applied to the products we provide to automakers and the aftermarket worldwide.



Delivering Asset Efficiency Optimization

Through SKF Reliability Systems, SKF provides a comprehensive range of asset efficiency products and services, from condition monitoring hardware and software to maintenance strategies, engineering assistance and machine reliability programmes. To optimize efficiency and boost productivity, some industrial facilities opt for an Integrated Maintenance Solution, in which SKF delivers all services under one fixed-fee, performance-based contract.



Planning for sustainable growth

By their very nature, bearings make a positive contribution to the natural environment, enabling machinery to operate more efficiently, consume less power, and require less lubrication. By raising the performance bar for our own products, SKF is enabling a new generation of high-efficiency products and equipment. With an eye to the future and the world we will leave to our children, the SKF Group policy on environment, health and safety, as well as the manufacturing techniques, are planned and implemented to help protect and preserve the earth's limited natural resources. We remain committed to sustainable, environmentally responsible growth.



General product information

Properties	14
Spherical plain bearings	14
Rod ends	15
Bearing designs and features	16
Bearings and rod ends requiring maintenance.....	17
The multi-groove system	17
Maintenance-free, long-life sliding contact surfaces	18
Optional SKF design features.....	19
A choice of materials	19
With or without seals.....	19
Wide operating temperature range	19
Multi-purpose performance	20
Typical applications.....	20
Application examples.....	20
Suspended roof.....	20
Road roller articulation joint.....	21
Truck twin-axle supports	21
Dam gates	22
Hydraulic and pneumatic cylinders.....	22
Newspaper conveyor	22

Properties

Spherical plain bearings

Spherical plain bearings are standardized, ready-to-mount, mechanical components that enable multi-directional, self-aligning movements. The inner ring has a spherical convex outside diameter, while the outer ring has a correspondingly concave inside diameter (→ **fig. 1**). The forces acting on the bearing may be static or may occur when the bearing makes oscillating or recurrent tilting and slewing movements at relatively low speeds.

Design advantages inherent to spherical plain bearings include the ability to:

- accommodate misalignment (→ **fig. 2**)
- virtually eliminate edge stresses and excessive stressing of adjacent components (→ **fig. 3**)
- accommodate deformation of surrounding components in operation (→ **fig. 4**)
- accommodate wide manufacturing tolerances and the use of cost-effective, welded assemblies (→ **fig. 5**)

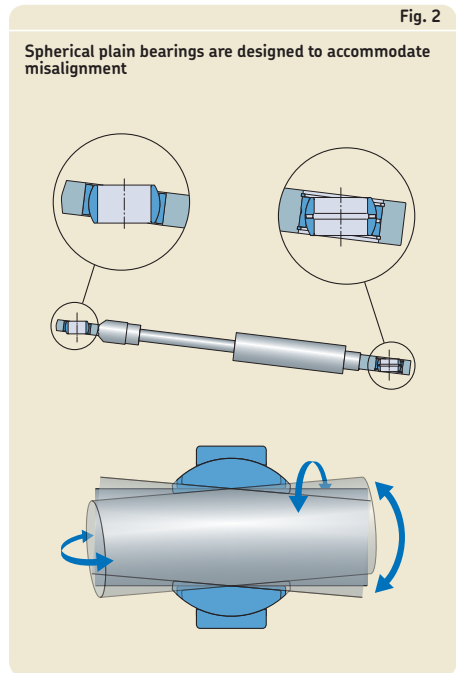
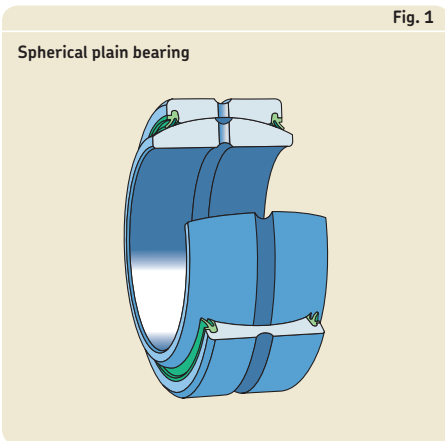

Fig. 3

Compared to bushings, spherical plain bearings provide higher reliability, as the chance of edge stresses and overloading are virtually non-existent

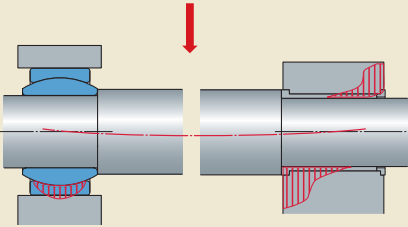

Fig. 4

Shaft deflection does not have a negative influence on bearing service life, the shaft or housing

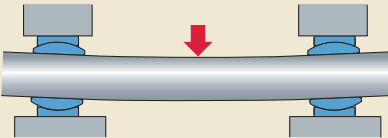
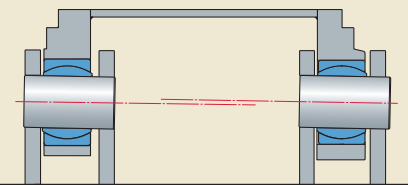

Fig. 5

Spherical plain bearings can accommodate the wide manufacturing tolerances found in cost-effective welded assemblies



Rod ends

Spherical plain bearing rod ends are bearing units that consist of a spherical plain bearing in the eye-shaped head of the rod end housing (→ fig. 6). They are used primarily on the ends of hydraulic or pneumatic pistons to join the cylinder to an associated component via an internal (female) thread, external (male) thread or a welding shank (→ fig. 7 on page 16).

SKF supplies rod ends with a threaded shank with a right-hand thread as standard. With the exception of rod ends with the designation suffix VZ019, all rod ends are also available with a left-hand thread. They are identified by the designation prefix L.

Fig. 6

Rod end with a male thread

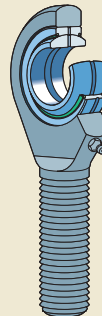

Bearing designs and features

SKF spherical plain bearings and rod ends are an excellent choice for applications that require total design economy. These state-of-the-art products are available in a wide assortment of designs, dimension series and sizes to meet the needs of a particular application. **Fig. 7** shows the general bearing and rod end types.

Whether the application calls for a large spherical plain bearing or a small rod end assembly, both are available from SKF and offer:

- long service life
- minimal maintenance
- high operational reliability

SKF spherical plain bearings and rod ends, produced with standard dimensions, are available

worldwide, making them readily accessible whenever and wherever they are needed.

Economic considerations and unparalleled design characteristics are not the only reasons that SKF spherical plain bearings and rod ends are the ultimate solution for any plain bearing application. Their designs, materials and manufacturing quality enable long service life and high reliability even in the most demanding applications.

Fig. 7

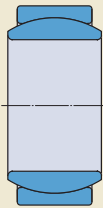

Radial spherical plain bearing



Angular contact spherical plain bearing

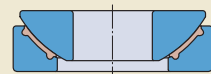

Thrust spherical plain bearing



Rod end with a female thread



Rod end with a male thread

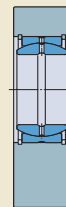

Rod end with a welding shank

Bearings and rod ends requiring maintenance

Bearings and rod ends requiring maintenance must be greased prior to being put into operation. With the exception of a few applications, they must be relubricated periodically.

SKF steel/steel radial spherical plain bearings are made of bearing steel and are through-hardened. The high-strength sliding contact surfaces are phosphated and treated with a special running-in lubricant. These bearings are used primarily in applications where there are:

- heavy static loads
- heavy alternating loads
- shock loads

They are also relatively insensitive to contaminants and high temperatures.

To facilitate relubrication, lubrication holes and grooves are provided in both the inner and outer rings of all steel/steel radial spherical plain bearings – with the exception of a few small sizes. SKF steel/bronze rod ends also require relubrication. However, requirements are less stringent than for steel/steel rod ends, as the emergency running properties of bronze are more forgiving than steel.

The multi-groove system

Standard steel/steel radial spherical plain bearings that must accommodate minor alignment movements under very heavy, constant direction loads are prone to lubricant starvation. To maximize the effects of the lubricant under these conditions, SKF has developed the multi-groove system and manufactures all metric steel/steel radial spherical plain bearings with an outside diameter $D \geq 150$ mm with the multi-groove system on the sliding surface of the outer ring as standard (→ **fig. 8**). Metric steel/steel radial spherical plain bearings with an outside diameter $D < 150$ mm can be supplied with the multi-groove system on request. These bearings are identified by the designation suffix ESL.

These lubrication grooves provide the following benefits:

- improved lubricant supply to the loaded zone
- enlarged lubricant reservoir in the bearing
- enable relubrication under load
- extended relubrication intervals
- space for wear particles and contaminants
- extended grease life

The main benefit of the multi-groove system is that it improves lubricant distribution in the heavily loaded zone to extend service life and/or maintenance intervals.

Fig. 8

Steel/steel radial spherical plain bearing with the multi-groove system



Maintenance-free, long-life sliding contact surfaces

“Maintenance-free” is an industry-wide term used to describe plain bearings and rod ends with self-lubricating sliding contact surface combinations. The term maintenance-free does not imply that these bearings should not be inspected as part of a regularly scheduled maintenance program.

These so-called maintenance-free bearings and rod ends offer a number of advantages for OEMs and end users alike. These advantages, which include minimal maintenance and reduced lubricant consumption, quickly compensate for the difference in the initial purchase price when compared to standard steel/steel bearing solutions. And of course, the impact that maintenance-free bearings have on the environment is an added benefit.

To offer maintenance-free solutions for the greatest number of applications, SKF produces spherical plain bearings and rod ends with different sliding contact surface combinations (→ fig 9). These combinations, which in some cases are size dependent, include:

- steel/PTFE (polytetrafluoroethylene) sintered bronze
- steel/PTFE fabric
- steel/PTFE FRP (fibre reinforced polymer)

Maintenance-free bearings can operate without grease, and therefore do not need to be relubricated. Depending on the sliding surfaces, grease

can improve bearing service life or can have a negative effect on it. Therefore, SKF does not recommend the use of lubricants for bearings with steel/PTFE sintered bronze or steel/PTFE fabric sliding contact surface combinations, whereas initial lubrication followed by occasional relubrication of steel/PTFE FRP bearings can extend the service life of the bearing.

Be aware that “maintenance-free” refers to bearing service life only, and does not refer to the service life of an application or general maintenance intervals of other machine parts in the application. For detailed information about the life of spherical plain bearings or rod ends, refer to the section *Basic rating life* starting on **page 39**. The basic rating life as a guideline value for the service life under certain operating conditions can be calculated using the information provided in the section *Basic rating life calculation* starting on **page 51**.

Self-lubricating, dry sliding materials are not as stiff as steel and consequently are subject to greater deformation under load than steel. These sliding materials are also more sensitive than steel to alternating or shock loads. If either of these load conditions exists, contact the SKF application engineering service.

Maintenance-free bearings and rod ends are designed for applications where:

- load direction is constant and may be heavy
- low coefficient of friction is necessary
- relubrication is not possible or difficult

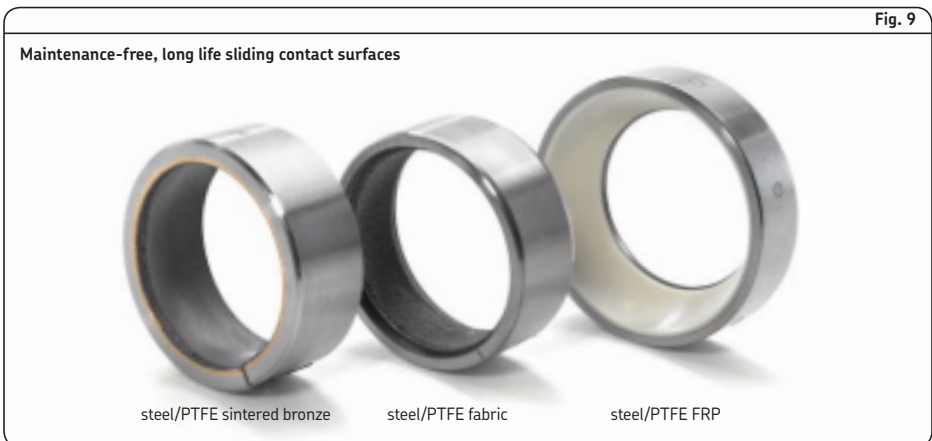

Optional SKF design features

A choice of materials

For most applications, SKF spherical plain bearings made of standard bearing steel requiring maintenance are an excellent choice. However, for difficult operating environments, SKF maintenance-free stainless steel spherical plain bearings may be preferred. For other material options, e.g. surface treatments, contact the SKF application engineering service.

With or without seals

Most popular sizes of SKF spherical plain bearings are available either open (without seals) or sealed on both sides (→ **fig. 10**). Standard sealed bearings can increase the service life of a bearing and save space, while reducing inventory and assembly costs. Maintenance-free bearings without seals have to be protected against contaminants.

Spherical plain bearings fitted on both sides with the SKF RS double lip seal are very effective, under normal operating conditions, at keeping contaminants away from the sliding contact surfaces. These seals also effectively retain the grease and therefore are appropriate for bearings requiring maintenance.

Maintenance-free bearings and all bearings operating in highly contaminated environments should be fitted with the SKF LS triple-lip heavy-duty contact seal (→ **page 79**). They are reinforced with a steel insert and have three seal lips. These very effective seals protect the bearing against contaminants and enhance the operational reliability of the spherical plain bearing.

Wide operating temperature range

SKF spherical plain bearings and rod ends can operate effectively over a wide temperature range. The operating temperature range of open (without seals) steel/steel radial spherical plain bearings is -50 to $+200$ °C.

Fig. 10

Many sealing problems can be solved economically and in a space-saving manner using sealed bearings

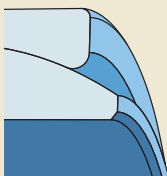

without seal
(open design)

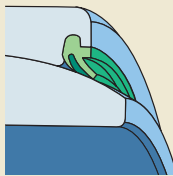

double-lip seal
(RS design)

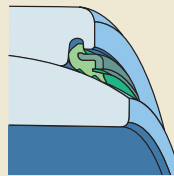

triple-lip heavy-duty seal
(LS design)

Multi-purpose performance

Typical applications

Long service life, high reliability and minimal maintenance are some of the features of SKF spherical plain bearings and rod ends. SKF's wide assortment of spherical plain bearings and rod ends is versatile enough to be used in a variety of applications that encompass almost all sectors of industry, including:

- agriculture
- construction
- forklift trucks
- material handling
- metals
- mining
- railways
- trucks
- wind energy

Application examples

Suspended roof

SKF steel/steel radial spherical plain bearings are in service in an unusual and world-renowned application, the roof of the Olympic Stadium in Munich, Germany (→ **fig. 11**). The roof is constructed of a number of pre-stressed steel cables in a network. The nodal points of the network must be torque-free. That is where 225 standard SKF steel/steel radial spherical plain bearings with bore diameters ranging from 160 to 300 mm are located. The nodes are statically loaded but must enable occasional swinging movements of the roof construction.

Although SKF steel/steel radial spherical plain bearings are typically not maintenance-free, these particular bearings have not been relubricated since the construction of the building in 1972.

What better proof could there be for lasting quality and reliability?

Fig. 11

Nodal points of suspended roof construction of the Olympic Stadium in Munich, Germany

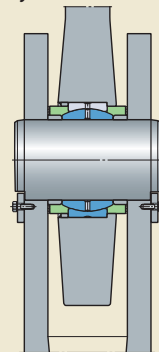
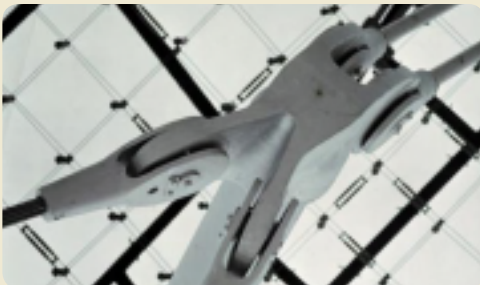

Road roller articulation joint

SKF spherical plain bearings in the articulation joint between the front and rear rollers (→ **fig. 12**) enable a road roller to manoeuvre. This joint must be able to withstand very heavy radial loads and high vibration levels. Due to their location, the bearings should be protected as they are exposed to a variety of contaminants including dust, dirt, water and hot tarmac, which promote premature wear and corrosion.

SKF maintenance-free spherical plain bearings help to eliminate the need for relubrication, and reduce the total cost of ownership.

Truck twin-axle supports

An SKF spherical plain bearing arrangement on the truck twin-axle support provides even load

distribution between the two axles for trucks driving on rough roads or off-highway conditions (→ **fig. 13**). This bearing arrangement is subjected to heavy loads and, depending on the conditions, heavy shock loads, and frequent alignment movements.

These bearings are located behind the tires in an area that is very difficult to access, making it imperative that sudden bearing damage or failure, requiring immediate roadside repairs, be avoided at all cost. A pair of SKF angular contact spherical plain bearings mounted in a back-to-back arrangement can help prevent these emergencies. These bearings, which can withstand all the rigours of truck duty, are simple to install and easy to maintain.

Fig. 12

Road roller articulation joint

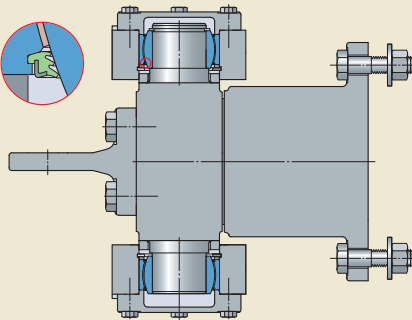
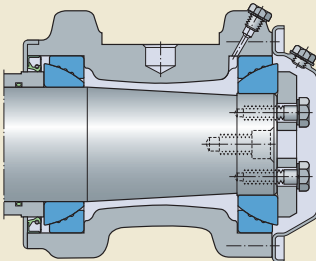

Fig. 13

Truck twin-axle supports



General product information

Dam gates

Segment gates for dams and other barrages are home to large-size SKF maintenance-free spherical plain bearings (→ **fig. 14**). The reference list is very long – with over 3 000 applications to date.

As main bearings, they compensate for shaft misalignment, caused by thermal expansion and contraction, elastic deformation of the dam gates as well as changes caused by settling of the foundation. These bearings cope with the heavy radial loads caused by water pressure as well as axial loads that arise from the inclined position of the support arms.

In addition, SKF spherical plain bearings not only serve as heavily loaded bearings under static conditions, they also operate in the frequently used linkage attachments of the lifting and plunger cylinders as well as the flaps.

Hydraulic and pneumatic cylinders

SKF steel/steel and steel/bronze rod ends are frequently used on hydraulic and pneumatic cylinders (→ **fig. 15**). Acting as the link between the cylinder and its attachments, they are able to transmit heavy mechanical loads.

Hydraulic cylinders (e.g. to ISO 8132) are often fitted with steel/steel rod ends with a female thread that can be secured (compressible) on one end and a steel/steel rod end with a welding shank on the other.

These types of hydraulic cylinders can be found in all types of construction equipment, agricultural machinery, lifting equipment and shutters, recycling depot presses as well as other heavily loaded manoeuvring equipment.

In pneumatic cylinders where working pressures regularly reach 1 MPa, steel/bronze rod ends and maintenance-free rod ends are typically used at the end of the piston rod. At the opposite end, SKF rod ends with a welding shank are used.

Newspaper conveyor

Speed and flexibility are all-important when producing newspapers, not only in the printing process, but also in distribution. The conveyor system from the printing press to the loading dock is a very important component if the newspapers are to be delivered on time.

The endless conveyor chain is one such system. It consists of a multitude of links, which together provide the speed and flexibility required. **Fig. 16** shows an application where more than 1 000 SKF maintenance-free spherical plain bearings with the sliding contact surface combination steel/PTFE sintered bronze are used. The bearings have been in daily service without maintenance for many years.

Fig. 14

Dam gates

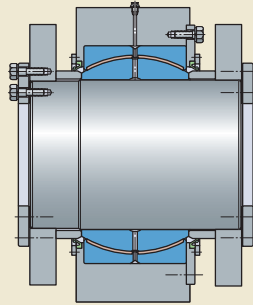
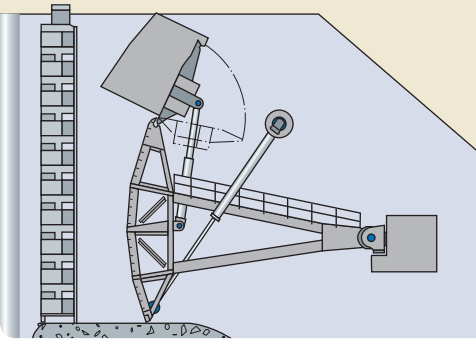

Fig. 15

Hydraulic and pneumatic cylinders

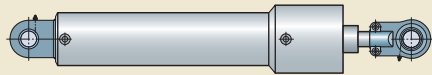
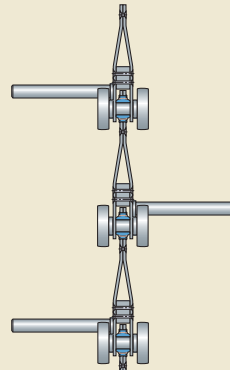
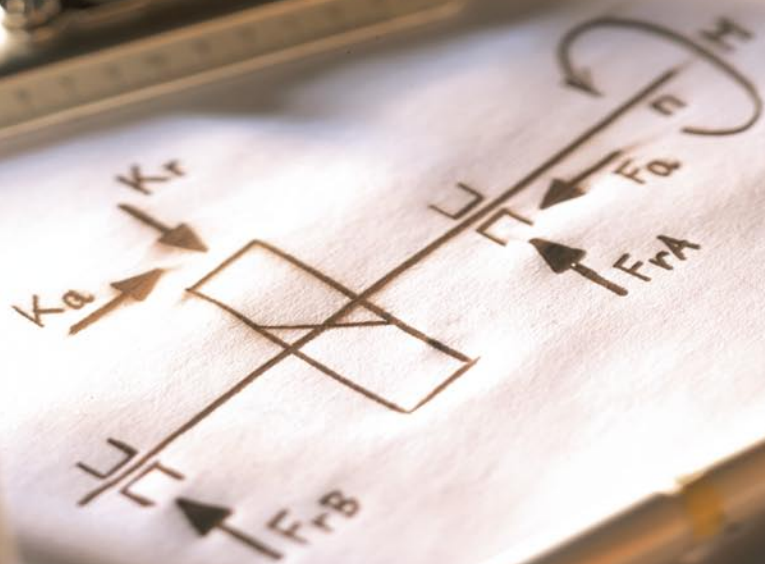

Fig. 16

Newspaper conveyor





Principles for selection and application

Selection of bearing type	25
Bearing terminology.....	27
Bearing types.....	28
Radial spherical plain bearings requiring maintenance.....	28
Maintenance-free radial spherical plain bearings	30
Angular contact spherical plain bearings	33
Thrust spherical plain bearings.....	34
Rod ends with a threaded shank, requiring maintenance	34
Rod ends with a welding shank, requiring maintenance	36
Maintenance-free rod ends with a threaded shank.....	37
Selection of bearing size	38
Load ratings	38
Basic dynamic load rating	38
Basic static load rating	38
Basic rating life	39
Load.....	41
Equivalent dynamic bearing load	41
Equivalent static bearing load	43
Permissible loads for rod ends	44
Requisite bearing size.....	45
Specific bearing load	46
Mean sliding velocity.....	46
Basic rating life calculation	51
Steel/steel and steel/bronze sliding contact surface combinations, requiring maintenance	51
Maintenance-free steel/PTFE sintered bronze sliding contact surface combination	54
Maintenance-free steel/PTFE fabric sliding contact surface combination	56
Maintenance-free steel/PTFE FRP sliding contact surface combination	59
Variable load and sliding velocity	61
Calculation examples.....	62
Friction	69
Design of bearing arrangements	70
Radial location of bearings.....	70
Axial location of bearings	75
Located bearings	75
Non-located bearings.....	75
Abutment and fillet dimensions	77

Location of rod ends	78
Sealing	79
Designing a bearing arrangement for easy mounting and dismounting	82
Lubrication	84
The SKF traffic light concept	84
Spherical plain bearings requiring maintenance	86
Maintenance-free spherical plain bearings	88
Steel/PTFE sintered bronze and steel/PTFE fabric sliding contact surface combinations ..	88
Steel/PTFE FRP sliding contact surface combination.....	88
Rod ends requiring maintenance.....	89
Maintenance-free rod ends	89
Relubrication	90
Mounting.....	92
Spherical plain bearings.....	92
Mechanical mounting	92
Hot mounting.....	94
Rod ends	95
Dismounting.....	96
Spherical plain bearings.....	96
Rod ends	96

Selection of bearing type

Bearing terminology

To better understand frequently used plain bearing and rod end specific terms, definitions are provided in **fig. 1** and **fig. 2**.

Spherical plain bearing

- 1 Outer ring
- 2 Sliding contact surfaces
- 3 Seal
- 4 Inner ring
- 5 Lubrication hole
- 6 Lubrication groove

Rod end

- 1 Spherical plain bearing
- 2 Rod end
 - 2a Rod end housing
 - 2b Rod end shank, with an external (male) thread. Shanks are also available with an internal (female) thread or with a welding shank.
- 3 Grease fitting

Fig. 1

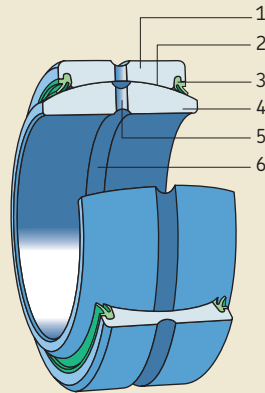
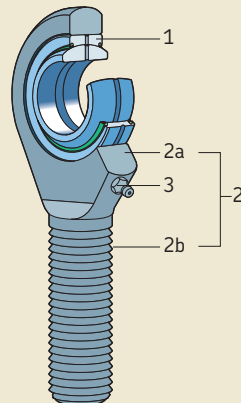

Fig. 2



Bearing types

All the products listed below belong to the SKF standard assortment:

- radial spherical plain bearings requiring maintenance
- maintenance-free radial spherical plain bearings
- angular contact spherical plain bearings
- thrust spherical plain bearings
- steel/steel and steel/bronze rod ends requiring maintenance
- maintenance-free rod ends

If the standard assortment does not meet the requirements of an application, SKF can produce special bearings or rod ends, provided quantities are sufficient to enable manufacturing economy.

Radial spherical plain bearings requiring maintenance

See chapter 2 starting on **page 99**

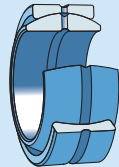
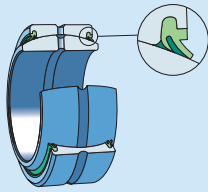
Bearing design Radial spherical plain bearings requiring maintenance	Designation/ bore diameter range	Characteristics
Sliding contact surface combination: Steel/steel Suitable for heavy static or alternating loads, shock loads		
	GE .. E d = 4 – 12 mm	Open (without seals), can only be relubricated from the side
	GE .. ES d = 15 – 200 mm GEZ .. ES d = 0,5 – 6 in	Open (without seals), can be relubricated via lubrication holes and an annular groove in both rings
	GE .. ES-2RS d = 15 – 300 mm GEZ .. ES-2RS d = 0,75 – 6 in	With a double-lip seal on both sides, can be relubricated via lubrication holes and an annular groove in both rings

Bearing design

Radial spherical plain bearings requiring maintenance

Designation/

bore diameter range

Characteristics**Sliding contact surface combination: Steel/steel**

Suitable for heavy static or alternating loads, shock loads

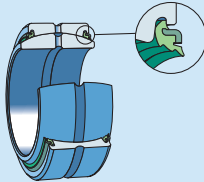
**GE .. ES-2LS**
d = 20 – 300 mm**GEZ .. ES-2LS**
d = 1 – 6 in

With a triple-lip heavy-duty seal on both sides, can be relubricated via lubrication holes and an annular groove in both rings

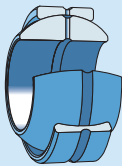
**GEH .. ES**
upon request**GEZH .. ES**
d = 1.25 – 5.5 in

Open (not sealed); wider inner ring and larger outside diameter compared to GE .. ES and GEZ .. ES series, to enable higher load ratings and larger tilt angle; can be relubricated via lubrication holes and an annular groove in both rings

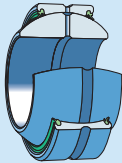
**GEH .. ES-2RS**
d = 20 – 120 mm**GEZH .. ES-2RS**
d = 1.25 – 5.5 in

With a double-lip seal on both sides; wider inner ring and larger outside diameter compared to GE .. ES-2RS and GEZ .. ES-2RS series, to enable higher load ratings and larger tilt angle; can be relubricated via lubrication holes and an annular groove in both rings

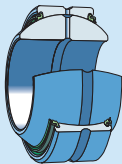
**GEH .. ES-2LS**
d = 20 – 120 mm**GEZH .. ES-2LS**
d = 1.25 – 5.5 in

With a triple-lip heavy-duty seal on both sides; wider inner ring and larger outside diameter compared to GE .. ES-2RS and GEZ .. ES-2RS series, to enable higher load ratings and larger tilt angle; can be relubricated via lubrication holes and an annular groove in both rings

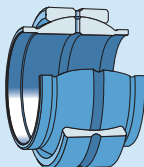
**GEM .. ES**
upon request**GEZM .. ES**
d = 0.5 – 6 in

Open (without seals); with an extended inner ring on both sides; can be relubricated via lubrication holes and an annular groove in both rings. For bearing arrangements where a spacer sleeve is normally incorporated on both sides of the inner ring.

GEG .. ES
d = 16 – 200 mm**GEG series** : The inner ring width equals the bore diameter**GEG 12 ESA**
d = 12 mm

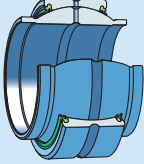
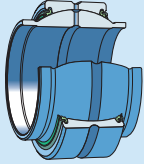

Can only be relubricated via the outer ring

Selection of bearing types

Bearing design	Designation/ bore diameter range	Characteristics
Sliding contact surface combination: Steel/steel Suitable for heavy static or alternating loads, shock loads		
	GEM .. ES-2RS d = 20 – 80 mm	With a double-lip seal and an extended inner ring on both sides, can be relubricated via lubrication holes and an annular groove in both rings
	GEZM .. ES-2RS d = 0.75 – 6 in	
	GEM .. ES-2LS d = 20 – 80 mm	With a triple-lip heavy-duty seal and an extended inner ring on both sides, can be relubricated via lubrication holes and an annular groove in both rings
	GEZM .. ES-2LS d = 1 – 6 in	

Maintenance-free radial spherical plain bearings

See chapter 3 starting on **page 125**

Bearing design	Designation/ bore diameter range	Characteristics
Sliding contact surface combination: Steel/PTFE sintered bronze Suitable for heavy, constant direction loads, where low friction is required; limited suitability for alternating loads, shock loads.		
	GE .. C d = 4 – 30 mm	Open (without seals), self-lubricating sliding surfaces have to be externally protected from contaminants
	GE .. CJ2 d = 35 – 60 mm	
	GEH .. C d = 10 – 25 mm	Open (without seals), self-lubricating sliding surfaces have to be externally protected from contaminants; wider inner ring and larger outside diameter compared to GE .. C series, to enable higher load ratings and larger tilt angle

Bearing design

Maintenance-free radial spherical plain bearings

Designation/

bore diameter range

Characteristics**Sliding contact surface combination: Steel/PTFE fabric**

Suitable for very heavy, constant direction loads, where low friction is required; limited suitability for alternating loads, shock loads

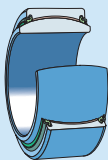
**GE .. TXE-2LS**
d = 20 – 90 mm**GEZ .. TXE-2LS**
d = 1 – 3.75 in**GE .. TXG3E-2LS**
d = 20 – 60 mm

High performance bearing with a triple-lip heavy-duty seal on both sides, outer ring fractured at one point, self-lubricating sliding surfaces

GE .. TXG3E-2LS series in stainless steel execution for use in corrosive environments

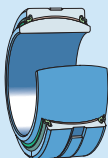
**GE .. TXA-2LS**
d = 100 – 300 mm**GEZ .. TXA-2LS**
d = 4 – 6 in**GE .. TXG3A-2LS**
d = 70 – 200 mm

High performance bearing with a triple-lip heavy-duty seal on both sides, axially split outer ring that is held together by one band, self-lubricating sliding surfaces

GE .. TXG3A-2LS series with rings made of stainless steel for use in corrosive environments

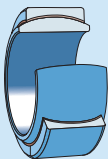
**GE .. TXGR**
d = 12 – 17 mm

Open (without seals), stainless steel execution for use in corrosive environments, self-lubricating sliding surfaces have to be externally protected from contaminants

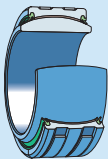
**GEC .. TXA-2RS**
d = 320 – 400 mm

High performance bearing with a double-lip seal on both sides, self-lubricating sliding surfaces, axially split outer ring that is held together by two bands

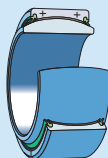
**GEC .. TXA-2RS**
d = 420 – 800 mm

High performance bearing with a double-lip seal on both sides, self-lubricating sliding surfaces, axially split outer ring that is bolted together

Selection of bearing types

Bearing design

Maintenance-free radial spherical plain bearings

Designation/

bore diameter range

Characteristics

Sliding contact surface combination: Steel/PTFE fabric

Suitable for very heavy, constant direction loads, where low friction is required; limited suitability for alternating loads, shock loads

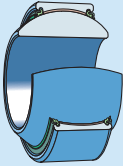

GEH ..TXE-2LS
d = 20 – 80 mm

High performance bearing with a triple-lip heavy-duty seal on both sides; self-lubricating sliding surfaces, wider inner ring and larger outside diameter compared to GE .. TXE-2LS series, to enable higher load ratings and larger tilt angle

GEH ..TXG3E-2LS
d = 20 – 50 mm

GEH .. TXG3E-2LS series with rings made of stainless steel for use in corrosive environments

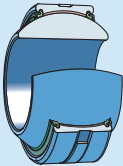

GEH ..TXA-2LS
d = 90 – 120 mm

High performance bearing with a triple-lip heavy-duty seal on both sides, self-lubricating sliding surfaces, wider inner ring and larger outside diameter compared to GE .. TXE-2LS series, to enable higher load ratings and larger tilt angle; axially split outer ring that is held together by one band

GEH ..TXG3A-2LS
d = 60 – 120 mm

GEH .. TXG3A-2LS series with rings made of stainless steel for use in corrosive environments

Sliding contact surface combination: Steel/PTFE FRP

Suitable for heavy, constant direction loads, where low friction is required; limited suitability for alternating loads, shock loads; relatively insensitive to contaminants

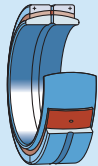

GEC .. FBAS
d = 320 – 1 000 mm

Open (without seals); axially split outer ring that is bolted together; self-lubricating capability; factory greased; lubrication holes and an annular groove in both rings; does not require relubrication, however, relubrication can extend bearing service life

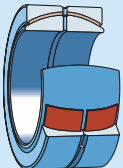



GEP .. FS
d = 100 – 1 000 mm

Open (without seals); radially split outer ring that is separable to facilitate mounting; self-lubricating capability; factory greased; lubrication holes and an annular groove in both rings; does not require relubrication, however, relubrication can extend bearing service life

Compared to GEC .. FBAS series, these bearings are wider and have a larger outside diameter for a given shaft size, resulting in a higher basic load rating. However, they have a smaller tilt angle.

Angular contact spherical plain bearings

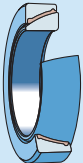
See chapter 4 starting on **page 151**

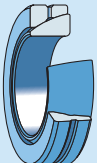
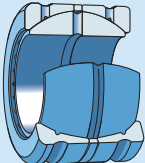
Bearing design Angular contact spherical plain bearings	Designation/ bore diameter range	Characteristics
<p>Sliding contact surface combination: Steel/PTFE FRP Suitable for single direction axial loads or combined axial and radial loads, low coefficient of friction, relatively insensitive to contaminants</p>	<p>GAC .. F d = 25 – 120 mm</p>	<p>Open (without seals); self-lubricating capability; factory greased; does not require relubrication, however, relubrication can extend bearing service life</p>
		
<p>Sliding contact surface combination: Steel/PTFE fabric Suitable for single direction axial loads or combined axial and radial loads, very high load carrying capacity and low coefficient of friction</p>	<p>GACD .. TX upon request</p>	<p>Open (without seals), high performance bearing with self-lubricating sliding surface</p>
		
<p>Sliding contact surface combination: Steel/steel Suitable for heavy single direction axial loads or heavy combined axial and radial loads, heavy alternating loads</p>	<p>GACD .. SA upon request GAZ .. SA upon request</p>	<p>Open (without seals), multi-groove system, can be relubricated via lubrication holes and an annular groove in the outer ring</p>
		
<p>Sliding contact surface combination: Steel/steel Double direction angular contact bearing with a standard inner ring, bearing can be used instead of two angular contact bearings in a face-to-face arrangement, suitable for heavy combined radial and axial loads, heavy alternating loads</p>	<p>GEZP(R) .. S upon request</p>	<p>Open (without seals), multi-groove system, can be relubricated via lubrication holes and an annular groove in the inner ring and the two outer rings</p>
		

Selection of bearing types

Thrust spherical plain bearings

See chapter 5 starting on **page 159**

Bearing design	Designation/ bore diameter range	Characteristics
Sliding contact surface combination: Steel/PTFE FRP Suitable for single direction axial loads or combined axial and radial loads, low coefficient of friction, relatively insensitive to contaminants	GX .. F d = 17 – 120 mm	Open (without seals); self-lubricating capability; factory greased; does not require relubrication, however, relubrication can extend bearing service life
Sliding contact surface combination: Steel/PTFE fabric Suitable for heavy single direction axial loads or combined axial and radial loads, very high load carrying capacity and low coefficient of friction	GXD .. TX upon request	Open (without seals), high performance bearing with self-lubricating sliding surface
Sliding contact surface combination: Steel/steel Suitable for heavy single direction axial loads or combined axial and radial loads, heavy alternating loads	GXD .. SA upon request	Open (without seals), multi-groove system, can be relubricated via lubrication holes and an annular groove in the housing washer

Rod ends with a threaded shank, requiring maintenance

See chapter 6 starting on **page 167**

Bearing design	Designation/ bore diameter range	Characteristics
Sliding contact surface combination: Steel/steel Suitable for heavy static or alternating loads, shock loads	SI(L) .. E d = 6 – 12 mm SA(L) .. E d = 6 – 12 mm	With an open bearing (without seals), no relubrication facilities, available with a right-hand or left-hand thread (designation prefix L)



SI series



SA series

Bearing design

Rod ends with a threaded shank, requiring maintenance

Designation/

bore diameter range

Characteristics**Sliding contact surface combination: Steel/steel**

Suitable for heavy static or alternating loads, shock loads

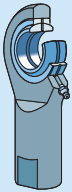

SI series

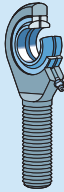

SA series

SI(L) .. ES

d = 15 – 30 mm

SA(L) .. ES

d = 15 – 30 mm

With an open bearing (without seals), can be lubricated via the relubrication facility in the rod end housing and via the pin (shaft), available with a right-hand or left-hand thread



SI(A) series

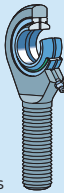

SA(A) series

SI(L) .. ES-2RS

d = 35 – 80 mm

SA(L) .. ES-2RS

d = 35 – 80 mm

SI(L)A .. ES-2RS

d = 40 – 80 mm

SA(L)A .. ES-2RS

d = 40 – 80 mm

With a double-lip seal on both sides of the bearing, can be lubricated via the relubrication facility in the rod end housing and via the pin (shaft), available with a right-hand or left-hand thread

SI(A) and SAA series with different fitting dimensions (thread, height of the housing)

Sliding contact surface combination: Steel/steel

Suitable for hydraulic cylinders, the slotted shank enables the rod end to be secured by tightening bolts

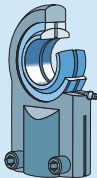
**SI(L)J .. ES**

d = 16 – 100 mm

With an open bearing (without seals), available with a right-hand or left-hand thread

Sizes 16 and larger can be lubricated via the relubrication facility in the rod end housing and via the pin (shaft)

SI(L)J 12 E

d = 12 mm

No relubrication facilities

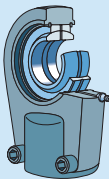
**SI(L)R .. ES**

d = 25 – 120 mm

With an open bearing (without seals), compact design, shorter female thread, can be lubricated via the relubrication facility in the rod end housing and via the pin (shaft), available with a right-hand or left-hand thread

**SI(L)QG .. ES**

d = 16 – 200 mm



With an open bearing (without seals), with an inner ring extended on both sides, can be lubricated via the relubrication facility in the rod end housing and via the pin (shaft), available with a right-hand or left-hand thread

SI(L)QG 12 ESA

d = 12 mm

Can only be lubricated via the relubrication facilities in the rod end housing

Selection of bearing types

Bearing design Rod ends with a threaded shank, requiring maintenance	Designation/ bore diameter range	Characteristics
Sliding contact surface combination: Steel/bronze Lower load carrying capacity compared to steel/steel rod ends, but more suitable for applications where lubricant starvation might occur		
	SI(L)KAC .. M $d = 5 - 30 \text{ mm}$	With an open bearing (without seals), available with a right-hand or left-hand thread
	SA(L)KAC .. M $d = 5 - 30 \text{ mm}$	Sizes 6 and larger can be lubricated via the relubrication facility in the rod end shank or housing
SIKAC .. M	SAKAC .. M	

Rod ends with a welding shank, requiring maintenance

See chapter 6 starting on **page 167**

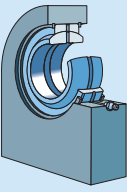
Bearing design Rod ends with a welding shank, requiring maintenance	Designation/ bore diameter range	Characteristics
Sliding contact surface combination: Steel/steel Suitable for heavy static or alternating loads, shock loads		
	SC ..ES $d = 20 - 80 \text{ mm}$	With an open bearing (without seals), can be lubricated via the relubrication facility in the rod end housing and via the pin (shaft) Primarily used for welding to piston rods and the bases of hydraulic cylinders Centred by a dowel pin
	SCF ..ES $d = 20 - 120 \text{ mm}$	With an open bearing (without seals); can be lubricated via the relubrication facility in the rod end housing and via the pin (shaft); high capacity design rod end compared to SC .. ES series, to enable heavier static loads Rectangular welding shank without a dowel pin

Maintenance-free rod ends with a threaded shank

See chapter 7 starting on **page 189**

Bearing design

Maintenance-free rod ends with a threaded shank

Designation/ bore diameter range

Characteristics

Sliding contact surface combination: Steel/PTFE sintered bronze

Suitable for heavy, constant direction loads, where low coefficient of friction is required; limited suitability for alternating loads, shock loads



SI..C



SA..C

SI(L) .. C

d = 6 – 30 mm

SA(L) .. C

d = 6 – 30 mm

With an open bearing (without seals), available with a right-hand or left-hand thread

Sliding contact surface combination: Steel/PTFE fabric

Suitable for very heavy, constant direction loads, where low coefficient of friction is required; limited suitability for alternating loads, shock loads



SI(A) .. TXE-2LS



SA(A) .. TXE-2LS

SI(L) .. TXE-2LS

d = 35 – 80 mm

SA(L) .. TXE-2LS

d = 35 – 80 mm

SI(L)A .. TXE-2LS

d = 40 – 60 mm

SA(L)A .. TXE-2LS

d = 40 – 60 mm

With a high performance bearing with a triple-lip heavy-duty seal on both sides of the bearing, available with a right-hand or left-hand thread

SIA and SAA series with different fitting dimensions (thread, height of the housing)

Sliding contact surface combination: Steel/PTFE FRP

Suitable for heavy, constant direction loads, where low coefficient of friction is required; limited suitability for alternating loads, shock loads



SIKB .. F



SAKB .. F

SI(L)KB .. F

d = 5 – 22 mm

SA(L)KB .. F

d = 5 – 22 mm

With an open bearing (without seals), but relatively insensitive to contaminants, available with a right-hand or left-hand thread

Selection of bearing size

Load ratings

There is no standardized method for determining the load ratings of spherical plain bearings and rod ends, nor is there any standardized definition. As different manufacturers define load ratings differently, it is not possible to compare the load ratings of bearings produced by one manufacturer with those of another.

Basic dynamic load rating

The basic dynamic load rating C is used, together with other influencing factors, to determine the basic rating life of spherical plain bearings and rod ends. As a rule, it represents the maximum load that a spherical plain bearing or rod end can accommodate at room temperature when there is movement between the sliding contact surfaces (→ **fig. 1**). The maximum load in any application should always be considered in relation to the required rating life. The basic dynamic load ratings quoted in the product tables are based on the specific load factor K (→ **table 4** on **page 45**) and the effective projected sliding surface.

Basic static load rating

The basic static load rating C_0 represents the maximum permissible load that a spherical plain bearing or rod end can accommodate when there is no relative movement between the sliding contact surfaces (→ **fig. 2**).

For spherical plain bearings, the basic static load rating represents the maximum load that the bearing can accommodate at room temperature without inadmissible deforming, fracturing or damaging the sliding contact surfaces.

The basic static load ratings quoted for SKF spherical plain bearings are based on a specific

Fig. 1

Dynamic bearing load

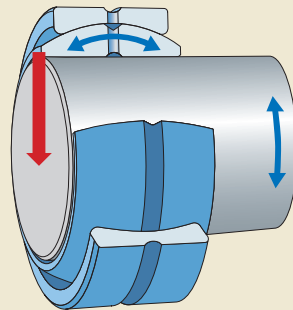
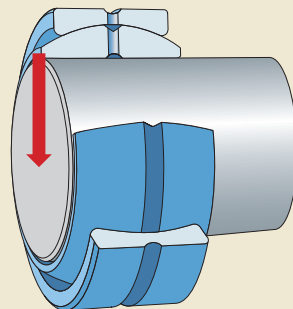
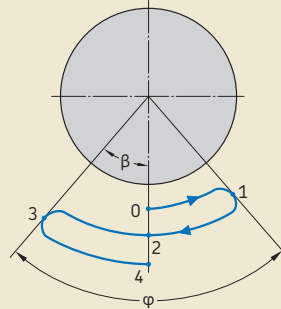

Fig. 2

Static bearing load



Angle of oscillation



$\varphi = \text{angle of oscillation} = 2\beta$
A complete oscillation is from point 0 to point 4 and = 4β

static load factor K_0 (→ table 4 on page 45) and the effective projected sliding surface. It is assumed that the bearing is adequately supported. To fully exploit the static load rating of a spherical plain bearing, it is generally necessary to use shafts and housings made of high-strength materials. The basic static load rating must also be considered when bearings are dynamically loaded and subjected to additional heavy shock loads. The total load in these cases must not exceed the basic static load rating.

For rod ends, it is the strength of the housing at room temperature, under a constant load acting in the direction of the shank axis, that is the determining factor. The basic static load rating represents a safety factor of at least 1,2 relative to the yield strength of the material of the rod end housing, under the above conditions.

Basic rating life

For spherical plain bearings, a lubricant film that fully separates the sliding contact surfaces cannot be formed. Therefore, the sliding contact surfaces make direct contact with each other, resulting in a certain and unavoidable degree of wear. This increases the internal clearance in the bearing.

Regarding the life of spherical plain bearings or rod ends, a distinction is made between the basic rating life and the service life. The basic rating life is a theoretical guideline value, used to estimate the service life. Service life depends on the actual operating conditions and is the actual life achieved by the bearing in service.

The basic rating life is based on a large number of laboratory tests. The bearings were tested for an operating period until a specific increase in bearing clearance or friction occurred (→ table 1 on page 40). The basic rating life considers several influencing factors and can be expressed in operating hours or the number of oscillating movements (→ fig. 3). In some cases, however, it is not possible to quantify factors such as contamination, corrosion, and complex kinematic loads. Therefore, the basic rating life can be attained or exceeded by

the majority of many apparently identical spherical plain bearings under the same operating conditions. For the calculation methods of the different sliding contact surface combinations as well as calculation examples, refer to the section *Basic rating life calculation* starting on page 51.

The service life cannot be calculated as it is too complex to determine and evaluate all the influencing factors. Therefore, depending on the application conditions, the service life may differ from the basic rating life.

NOTE: By using the *SKF Interactive Engineering Catalogue* and its incorporated calculation programs, it is possible to perform the necessary calculations to select a spherical plain bearing with the click of a mouse. The product data necessary for the calculations is automatically put in by selecting a spherical plain bearing or rod end from the product tables. It is then only necessary to fill in the fields for the operating data.

The *SKF Interactive Engineering Catalogue* is available online at www.skf.com.

Selection of bearing size

Table 1

Failure criteria for basic rating life tests

Sliding contact surface combination	Increase in bearing clearance	Coefficient of friction μ
–	mm	–
Steel/steel	$> 0,004 d_k^{1)}$	0,20
Steel/bronze	$> 0,004 d_k^{1)}$	0,25
Steel/PTFE²⁾ sintered bronze		
constant direction load	0,2	0,25
alternating direction load	0,4	0,25
Steel/PTFE fabric		
constant direction load	0,3	0,15
alternating direction load	0,6	0,15
Steel/PTFE FRP³⁾	design and size dependent	0,20

¹⁾ d_k = sphere diameter of the inner ring.

²⁾ Polytetrafluoroethylene.

³⁾ Fibre reinforced polymer.

Fig. 4

Radial load

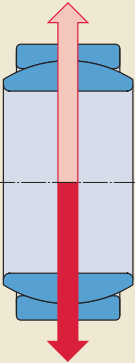

Fig. 5

Axial load

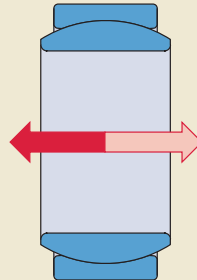

Fig. 6

Combined load

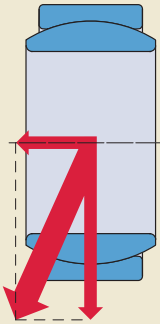

Fig. 7

Constant direction load

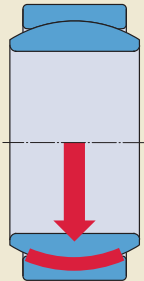
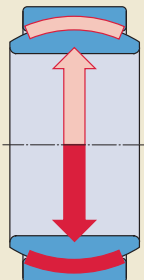

Fig. 8

Alternating direction load



Load

When considering load, a distinction is made between:

- load direction
 - radial load (→ **fig. 4**)
 - axial load (→ **fig. 5**)
 - combined (axial and radial) load (→ **fig. 6**)
- type of load
 - dynamic load, i.e. there is relative sliding movement in the loaded bearing
 - static load, i.e. there is no relative movement in the loaded bearing
- load conditions
 - constant load (→ **fig. 7**), i.e. the direction in which the load is applied does not change and the same part of the bearing (loaded zone) is always subjected to the load
 - alternating load (→ **fig. 8**), i.e. change of load direction so that zones at opposite positions in the bearing are alternately loaded and unloaded

Equivalent dynamic bearing load

The load can be inserted directly into the equation for the specific bearing load p (→ **page 46**) if the magnitude of the load is constant and if the load acting on:

- radial and angular contact spherical plain bearings is purely radial
- thrust spherical plain bearings is purely axial
- rod ends is purely radial and in the direction of the shank axis

In all other cases it is necessary to calculate the equivalent dynamic bearing load P . If the magnitude of the load is not constant, use the equation provided in the section *Variable load and sliding velocity* (→ **page 61**).

Selection of bearing size

Radial spherical plain bearings

Radial spherical plain bearings can accommodate a certain magnitude of axial load F_a in addition to a simultaneously acting radial load F_r (→ **fig. 6 on page 41**). When the resultant load is constant in magnitude, the equivalent dynamic bearing load can be calculated using

$$P = y F_r$$

where

P = equivalent dynamic bearing load [kN]

F_r = radial component of the load [kN]

y = load factor that depends on the ratio of the axial to the radial load F_a/F_r

– for bearings requiring maintenance

(→ **diagram 1**)

– for maintenance-free bearings

(→ **diagram 2**)

Diagram 1

Factor y for radial spherical plain bearings requiring maintenance

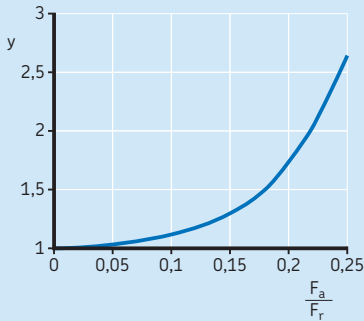

Diagram 2

Factor y for maintenance-free radial spherical plain bearings

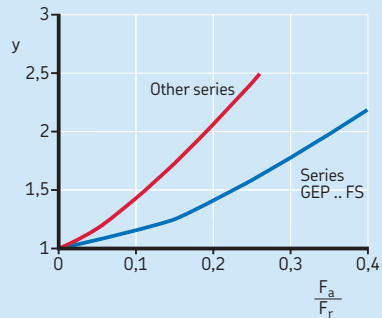
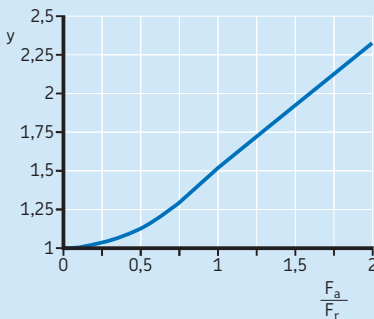

Diagram 3

Factor y for angular contact spherical plain bearings



If $F_a/F_r > 2$, use a thrust spherical plain bearing instead, or contact the SKF application engineering service.

Diagram 4

Factor y for thrust spherical plain bearings

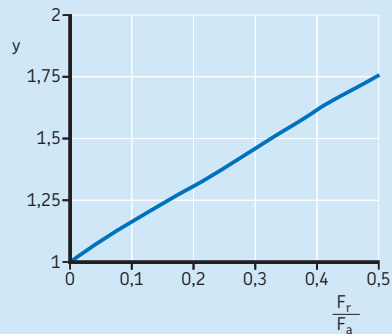

If $F_r/F_a > 0.5$, use an angular contact spherical plain bearing instead, or contact the SKF application engineering service.

Angular contact spherical plain bearings

When the resultant load (\rightarrow **fig. 9**) is constant in magnitude, then use

$$P = y F_r$$

where

P = equivalent dynamic bearing load [kN]

F_r = radial component of the load [kN]

y = load factor that depends on the ratio of the axial to the radial load F_a/F_r (\rightarrow **diagram 3**)

Thrust spherical plain bearings

Thrust spherical plain bearings can accommodate a radial load F_r in addition to an axial load F_a (\rightarrow **fig. 10**). However, the radial load must not exceed 50% of the simultaneously acting axial load. When the resultant load is constant in magnitude, then use

$$P = y F_a$$

where

P = equivalent dynamic bearing load [kN]

F_a = axial component of the load [kN]

y = load factor depending on the ratio of the radial to the axial load F_r/F_a (\rightarrow **diagram 4**)

Equivalent static bearing load

If spherical plain bearings and rod ends are subjected to static loads, or very slight alignment movements, then the permissible load is not limited by wear, but by the strength of the sliding contact layer or the strength of the rod end housing.

If the actual load is a combined load, then an equivalent static bearing load must be calculated. For radial and angular contact spherical plain bearings, it can be calculated using

$$P_0 = y F_r$$

For thrust spherical plain bearings, it can be calculated using

$$P_0 = y F_a$$

Fig. 9

Angular contact spherical plain bearing under combined load

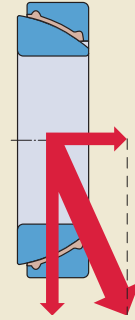
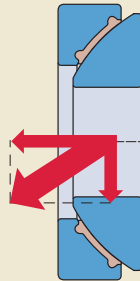

Fig. 10

Thrust spherical plain bearing under combined load



where

P_0 = equivalent static bearing load [kN]

F_r = radial component of the load [kN]

F_a = axial component of the load [kN]

y = load factor that depends on the ratio of the axial to the radial load F_a/F_r

– for radial bearings requiring maintenance (\rightarrow **diagram 1**)

– for maintenance-free radial bearings (\rightarrow **diagram 2**)

– for angular contact spherical plain bearings (\rightarrow **diagram 3**)

and load factor that depends on the ratio of the radial to the axial load F_r/F_a

– for thrust spherical plain bearings (\rightarrow **diagram 4**)

Permissible loads for rod ends

Rod ends are primarily intended for the support of radial loads acting in the direction of the shank axis. If loads act at angles to the shank axis (→ **fig. 11**), the maximum permissible load is reduced, as additional bending stresses occur in the shank. Under these conditions, consider the design and size dependent material used for the rod end housing (→ **table 6** on **page 170**).

The load portion acting perpendicular to the direction of the shank axis should never exceed the value of 0,1 C₀. If heavier loads are involved, a larger rod end should be selected.

The maximum permissible load for a rod end in the direction of the shank axis can be calculated using

$$P_{perm} = C_0 b_2 b_6$$

where

P_{perm} = maximum permissible load [kN]

C₀ = static load rating [kN]

b₂ = temperature factor

- for rod ends requiring maintenance (→ **table 5** on **page 52**)
- for maintenance-free rod ends with the sliding contact surface combination
 - steel/PTFE sintered bronze (→ **diagram 16** on **page 55**)
 - steel/PTFE fabric (→ **diagram 17** on **page 56**)
 - steel PTFE FRP (→ **diagram 19** on **page 59**)

b₆ = factor for the type of load (→ **table 2**)

Fig. 11

Rod end under combined load

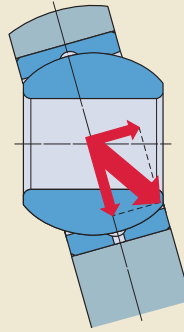

Table 2

Factor b₆ for rod end load type

Type of load	Factor b ₆
Constant	1
Pulsating magnitude (single direction)	0,5 (0,35)
Alternating direction	0,5 (0,35)

The values in brackets apply to rod ends with a relubrication facility.

Requisite bearing size

To determine the requisite size of a spherical plain bearing or rod end, it is necessary to know the requisite rating life for the application. This depends on the type of machine, the operating conditions and the demands regarding operational reliability. The following steps can be used to determine requisite bearing size:

- 1 Use the guideline values of the load ratio C/P provided in **table 3** to obtain a requisite basic dynamic load rating C . Compare this value with the basic dynamic load rating of the bearings listed in the product tables.
- 2 Use **diagrams 5 to 10** on **pages 46 to 50** to check whether the sliding contact surface combination of the selected bearing or rod end can be used under the actual load p and sliding velocity v conditions. The specific bearing load p and the sliding velocity v needed to perform this check can be calculated as explained in the following sections:
 - a) If the p v diagram indicates that the basic rating life equation can be used, proceed to step 3.
 - b) If the p v diagram shows that the p v range is exceeded, select a bearing with a higher load carrying capacity.
- 3 Calculate the basic rating life (**→ page 51**) and proceed as follows:
 - a) If the calculated rating life is shorter than the requisite rating life, a larger bearing or rod end should be selected and the calculation repeated.
 - b) If the calculated rating life is larger than the requisite rating life, the bearing or rod end can be selected for the application.

The bearing or rod end size is often determined by the dimensions of the associated components. In these cases, check the p v diagram to determine if the product is suitable.

Table 3

Guideline values for C/P	
Sliding contact surface combination	Load ratio C/P
Steel/steel	2
Steel/bronze	2
Steel/PTFE sintered bronze	1,6
Steel/PTFE fabric	2
Steel/PTFE FRP	
GAC .. F	1,25
GX .. F	1,25
GEP .. FS	1,6
GEC .. FBAS	1,6
Rod ends	1,25

Table 4

Sliding contact surface combination	Specific load factors	
	dyn. K	stat. K_0
–	N/mm ²	
Steel/steel		
Metric bearings	100	500
Inch bearings	100	300
Steel/bronze	50	80
Steel/PTFE sintered bronze	100	250
Steel/PTFE fabric		
Metric bearings	300	500
Inch bearings	150	300
Steel/PTFE FRP		
GAC .. F	50	80
GX .. F	50	80
GEP .. FS	80	120
GEC .. FBAS	80	120
Rod ends	50	80

Selection of bearing size

Specific bearing load

The magnitude of the specific bearing load can be calculated using

$$p = K \frac{P}{C}$$

where

p = specific bearing load [N/mm²]

K = specific load factor depending on the bearing design and sliding contact surface combination (→ **table 4** on **page 45**) [N/mm²]

P = equivalent dynamic bearing load [kN]

C = basic dynamic load rating [kN]

Mean sliding velocity

The mean sliding velocity for constant movement can be calculated using

$$v = 5,82 \times 10^{-7} d_m \beta f$$

where

v = mean sliding velocity [m/s]

When the operation is intermittent (not continuous), the mean sliding velocity should be calculated for a cycle of operation

d_m = inner ring mean diameter [mm]

$d_m = d_k$ for radial spherical plain bearings and rod ends

$d_m = 0,9 d_k$ for angular contact spherical plain bearings

$d_m = 0,7 d_k$ for thrust spherical plain bearings

d_k = inner ring sphere diameter [mm]

β = half the angle of oscillation (→ **fig. 3** on **page 39**), degrees [°], for rotation $\beta = 90^\circ$

f = frequency of oscillation [min⁻¹], or rotational speed [min⁻¹]

Diagram 5

pv diagram for steel/steel sliding contact surface combination

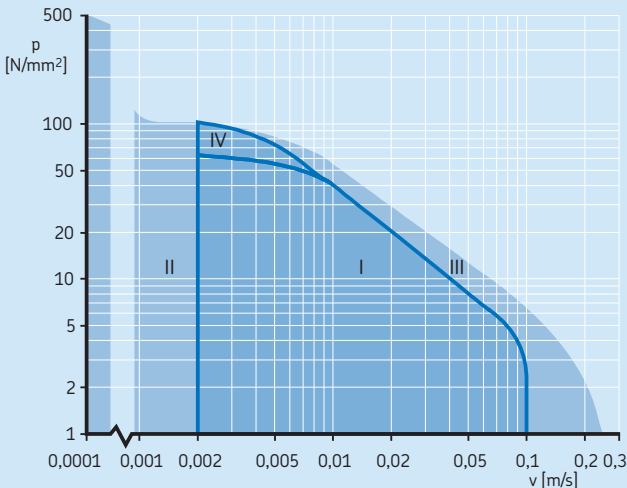

Refer to Note 1 (→ **page 47**) for explanation of operating ranges.

For intermittent movement, the angle of oscillation is usually given in units of time. In this case the mean sliding velocity can be calculated using

$$v = 8,73 \times 10^{-6} d_m \frac{4\beta}{t}$$

where

β = half the angle of oscillation [°]

(→ fig. 3 on page 39)

t = time taken to pass through complete oscillation [s]

NOTE 1: pv operating ranges

- I Range where rating life equation is valid
- II Quasi-static range; before using the rating life equation, contact the SKF application engineering service
- III Possible range of use, e.g. with very good lubrication; before using the rating life equation, contact the SKF application engineering service for additional information
- IV Extended range where rating life equation is valid provided the load is exclusively alternating

Diagram 6

pv diagram for steel/bronze sliding contact surface combination

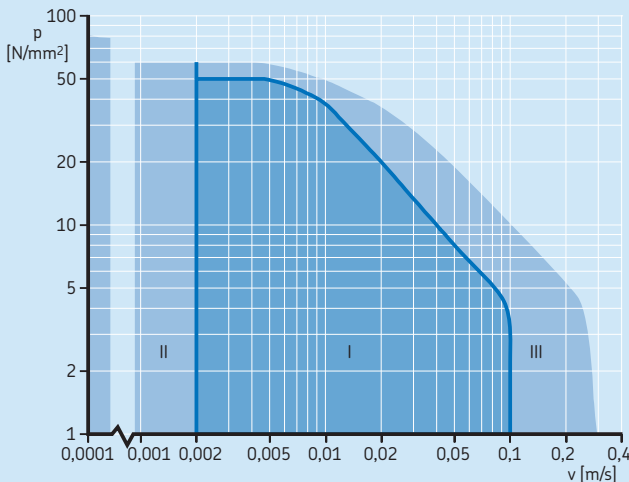

Refer to Note 1 for explanation of operating ranges.

Selection of bearing size

NOTE 2: pv operating ranges

- I Range where rating life equation is valid
- II Quasi-static range; rating life equation has limited validity, refer to the section *Basic rating life*, starting on **page 39**
- III Possible range of use, e.g. with very good heat dissipation; before using the rating life equation, contact the SKF application engineering service for additional information

Diagram 7

pv diagram for steel/PTFE sintered bronze sliding contact surface combination

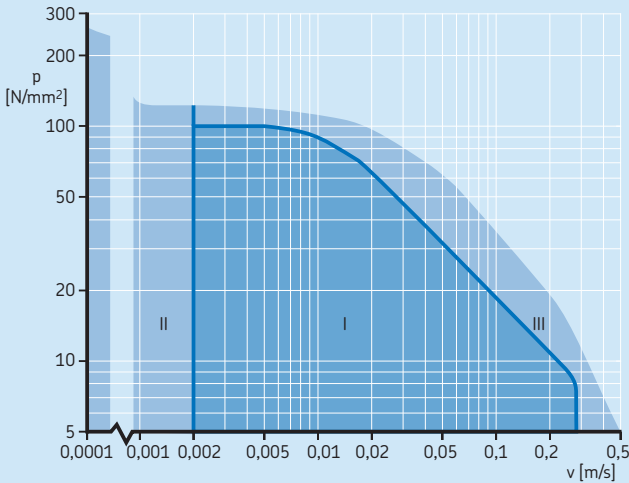

Refer to Note 2 for explanation of operating ranges.

pv diagrams for steel/PTFE fabric sliding contact surface combination

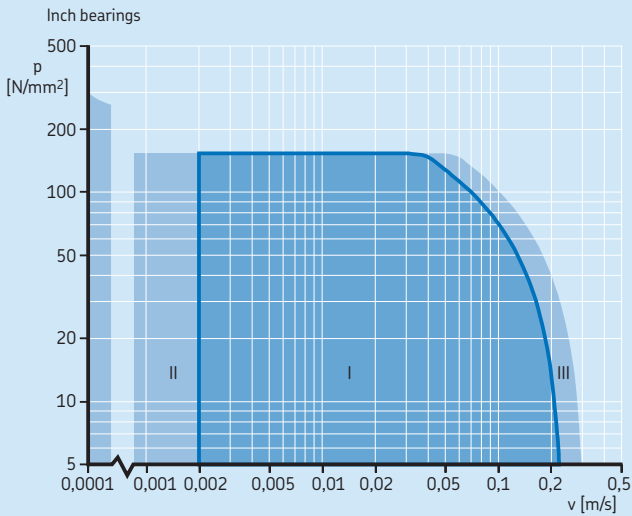
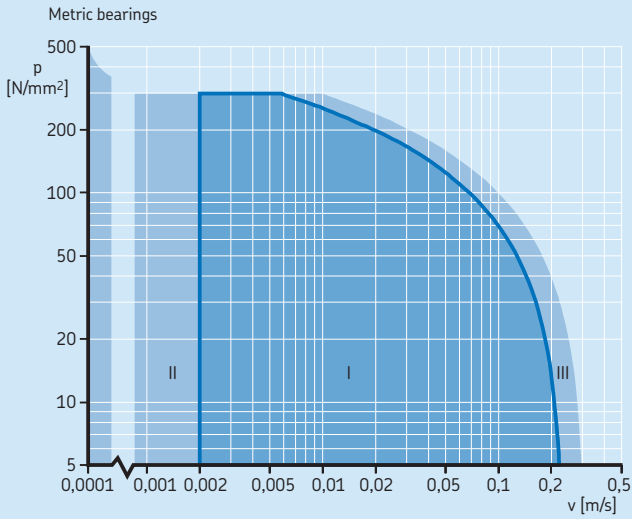

Refer to Note 2 (→ page 48) for explanation of operating ranges.

Diagram 9

pv diagram for steel/PTFE FRP sliding contact surface combination, FS and FBAS designs

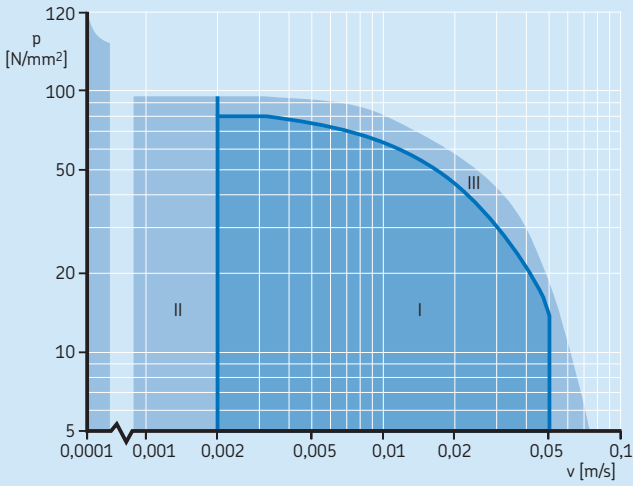

Refer to Note 2 (→ page 48) for explanation of operating ranges.

Diagram 10

pv diagram for steel/PTFE FRP sliding contact surface combination, F design

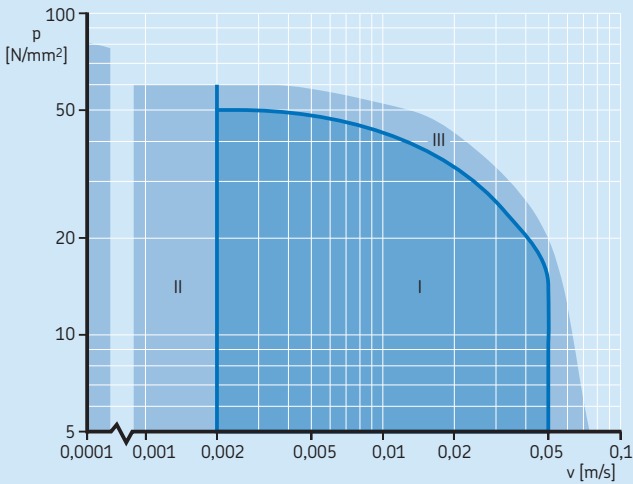

Refer to Note 2 (→ page 48) for explanation of operating ranges.

Basic rating life calculation

Steel/steel and steel/bronze sliding contact surface combinations, requiring maintenance

The basic rating life for initial lubrication only, can be calculated using

$$G_h = b_1 b_2 b_3 b_4 b_5 \frac{330}{p^{2.5} v}$$

When the bearing is regularly relubricated after the initial lubrication

$$G_{hN} = G_h f_\beta f_H$$

or

$$G_N = 60 f G_{hN}$$

The frequency of relubrication can be calculated using

$$H = \frac{G_h}{N}$$

where

G_h = basic rating life with initial lubrication only, operating hours [h]

G_{hN} = basic rating life with regular relubrication, operating hours [h]

G_N = basic rating life with regular relubrication, number of oscillations

H = frequency of relubrication (→ **diagram 15** on **page 53**)

b_1 = load condition factor,
 $b_1 = 1$ for constant direction load
 $b_1 = 2$ for alternating direction load

b_2 = temperature factor (→ **table 5** on **page 52**)

b_3 = sliding factor (→ **diagram 11**)

b_4 = velocity factor (→ **diagram 12** on **page 52**)

b_5 = factor for angle of oscillation (→ **diagram 13** on **page 52**), refer to *Note* (→ **page 53**)

p = specific bearing load [N/mm²] (for values of $p < 10$ N/mm² use $p = 10$ N/mm²)

v = mean sliding velocity [m/s]

f_β = factor depending on the angle of oscillation (→ **diagram 14** on **page 53**), refer to *Note* (→ **page 53**)

f_H = factor depending on the frequency of relubrication (→ **diagram 15** on **page 53**)

f = frequency of oscillation [min⁻¹]

N = relubrication interval [h]

If the basic rating life requirement is not met, the relubrication interval N should be shortened, or a larger bearing or rod end should be selected.

Diagram 11

Sliding factor b_3 for steel/steel and steel/bronze sliding contact surface combinations

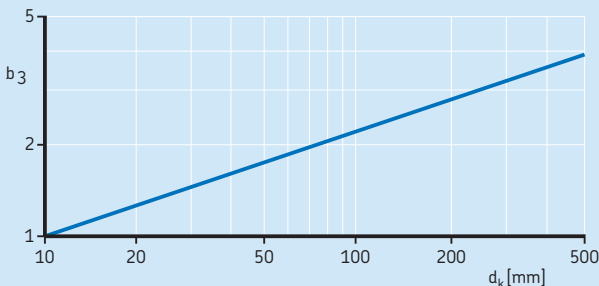

Velocity factor b_4 for steel/steel and steel/bronze sliding contact surface combinations

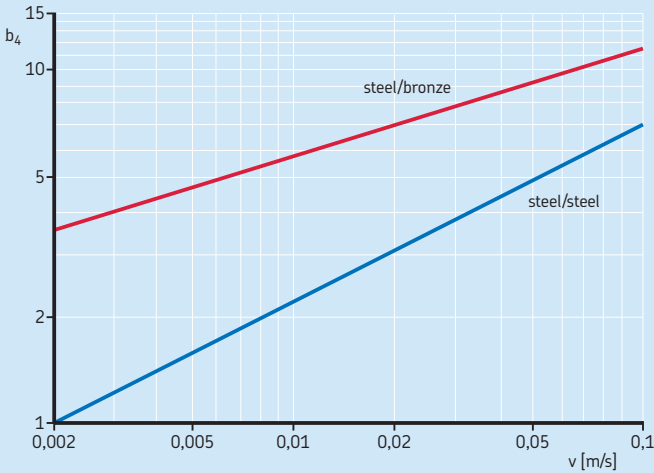

Table 5

Temperature factor b_2 for steel/steel and steel/bronze sliding contact surface combinations

Operating temperature		Temperature factor b_2
over	incl.	
°C	–	
–	120	1,0
120	160	0,9
160	180	0,8
180	–	Contact the SKF application engineering service

The temperature limits for integral seals (→ table 6 on page 79) and SKF greases (→ table 1 on page 87) must also be considered.

Diagram 13

Angle of oscillation factor b_5 for steel/steel and steel/bronze sliding contact surface combinations

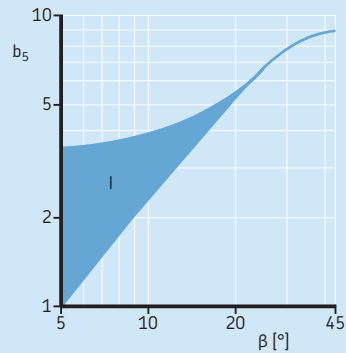

If $\beta < 5^\circ$, the value of b_5 for $\beta = 5^\circ$ should be used.

Diagram 14

Multiplication factor f_{β} for steel/steel and steel/bronze sliding contact surface combinations

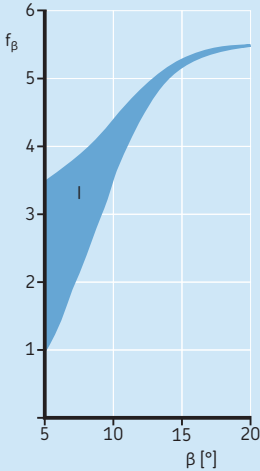

If $\beta < 5^\circ$, the value of f_{β} for $\beta = 5^\circ$ should be used.

NOTE: SKF manufactures all metric steel/steel radial spherical plain bearings with an outside diameter $D \geq 150$ mm as standard with the multi-groove feature in the outer ring (→ page 17). The extra large grease reservoir in the bearing, made possible by the multi-groove system, extends relubrication intervals and bearing service life, especially in applications where there are constant direction loads (→ page 40).

These advantages are considered in the calculation of the basic rating life by the coloured regions in diagrams 13 and 14 for the factors for the angle of oscillation b_5 and f_{β} . The values of these two factors in the upper limit of the coloured area may be used for bearings with the multi-groove system.

Diagram 15

Relubrication factor f_H for steel/steel and steel/bronze sliding contact surface combinations

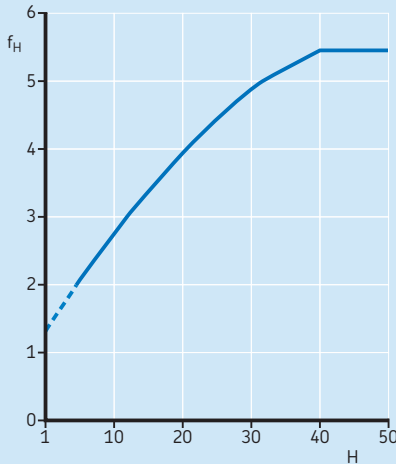

If $H < 5$, the values indicated by the broken line can be used.

Selection of bearing size

Maintenance-free steel/PTFE sintered bronze sliding contact surface combination

The basic rating life can be calculated using

$$G_h = b_1 b_2 \frac{1\,400}{p^{1.3} v}$$

or

$$G = 60 f G_h$$

where

G_h = basic rating life, operating hours

G = basic rating life, number of oscillations

b_1 = load condition factor (→ **table 6**)

b_2 = temperature factor (→ **diagram 16**)

p = specific bearing load [N/mm²]

v = mean sliding velocity [m/s]

f = frequency of oscillation [min⁻¹]

NOTE: Basic rating life calculations consider the influence of the load and sliding velocity. Under very light loads and/or low sliding velocities, the result shows relatively long life. The longer the service life the more important is the influence of contaminants such as dirt, moisture and corrosion. Depending on the operating conditions, accurate life calculations may not be possible.

Table 6

Load condition factor b_1 for the steel/PTFE sintered bronze sliding contact surface combination

Type of load	Factor b_1	Permissible specific bearing load ¹⁾
–	–	N/mm ²
Constant load²⁾ Single direction	1	up to 100
Variable load Alternating direction or pulsating magnitude at a frequency up to 0,5 Hz over 0,5 up to 5 Hz	0,4 0,2	up to 60 up to 40

¹⁾ Inertia forces should also be taken into consideration.

²⁾ For constant load, oscillating frequencies above 300 min⁻¹ and very short sliding distances, $b_1 = 1$ cannot be used because of possible material fatigue. For additional information, contact the SKF application engineering service.

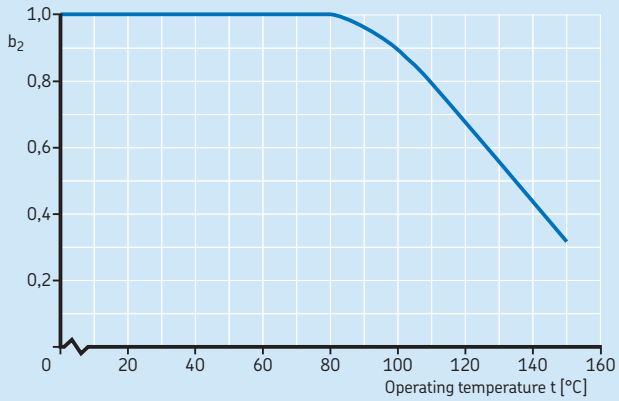
Temperature factor b_2 for the steel/PTFE sintered bronze sliding contact surface combination

Selection of bearing size

Maintenance-free steel/PTFE fabric sliding contact surface combination

The basic rating life can be calculated using

$$G_h = b_1 b_2 b_4 \frac{K_p}{p^n v}$$

or

$$G = 60 f G_h$$

where

G_h = basic rating life, operating hours

G = basic rating life, number of oscillations

b_1 = load condition factor (→ **table 7**)

b_2 = temperature factor (→ **diagram 17**)

b_4 = velocity factor (→ **diagram 18** on **page 58**)

K_p = constant for the specific bearing load
(→ **table 8**)

p = specific bearing load [N/mm²]

n = exponent for the specific bearing load
(→ **table 8**)

v = mean sliding velocity [m/s]

f = frequency of oscillation [min⁻¹]

NOTE: Basic rating life calculations consider the influence of the load and sliding velocity. Under very light loads and/or low sliding velocities, the result shows relatively long life. The longer the service life the more important is the influence of contaminants such as dirt, moisture and corrosion. Depending on the operating conditions, accurate life calculations may not be possible.

Diagram 17

Temperature factor b_2 for steel/PTFE fabric sliding contact surface combination

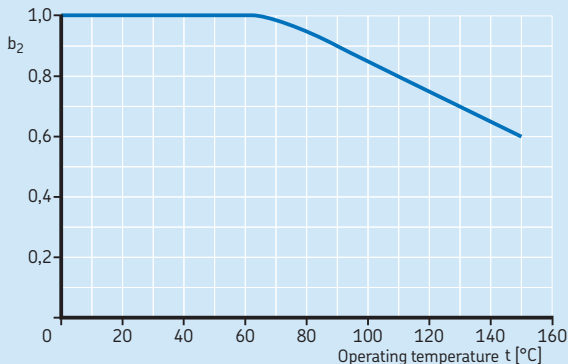

Table 7

Load condition factor b_1 for steel/PTFE fabric sliding contact surface combination

Type of load	Factor $b_1^{1)}$	Specific bearing load
–	–	N/mm ²
Constant		
Single direction	1	up to 300
Variable load		
Alternating direction or pulsating magnitude at a frequency up to 0,5 Hz	0,55 0,4	up to 50 50 to 100
over 0,5 to 1 Hz	0,35 0,15	up to 50 50 to 100
over 1 to 5 Hz	0,1	up to 50

¹⁾The factor b_1 covers several parameters that affect the bearing life. Depending on the operating conditions, higher b_1 values can be applied. Contact the SKF application engineering service.

Table 8

Constant K_p and exponent n for steel/PTFE fabric sliding contact surface combination

Specific bearing load ¹⁾ over incl.		Constant K_p	Exponent n
N/mm ²		–	–
–	25	770	0,2
25	90	4 000	0,7
90	300	40 000	1,2

¹⁾For inch bearings, specific bearing load may not exceed 150 N/mm² (→ table 4 on page 45).

Velocity factor b_v for steel/PTFE fabric sliding contact surface combination

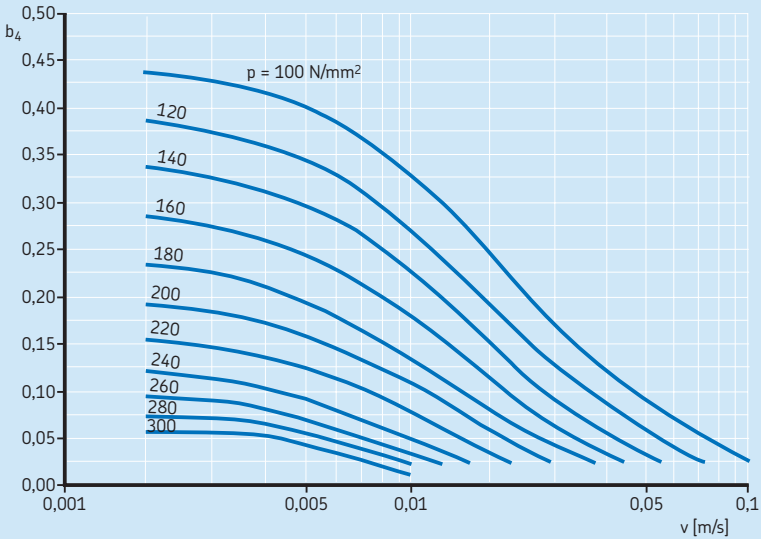
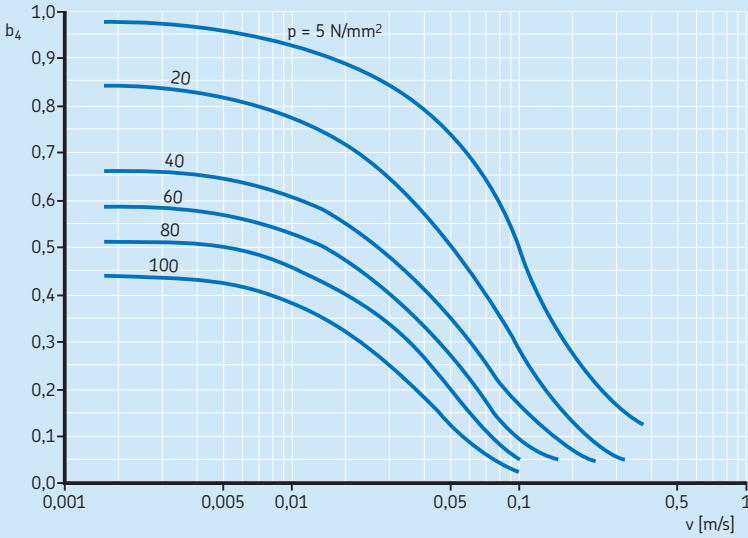

Maintenance-free steel/PTFE FRP sliding contact surface combination

The basic rating life can be calculated using

$$G_h = b_1 b_2 b_3 \frac{K_M}{p v}$$

or

$$G = 60 f G_h$$

where

- G_h = basic rating life, operating hours
- G = basic rating life, number of oscillations
- b_1 = load condition factor (→ **table 9**)
- b_2 = temperature factor (→ **diagram 19**)
- b_3 = sliding factor (→ **table 10** on **page 60**)
- K_M = material constant (→ **table 10** on **page 60**)
- p = specific bearing load [N/mm^2]
- v = mean sliding velocity [m/s]
- f = frequency of oscillation [min^{-1}]

NOTE:

- The basic rating life calculated from the above equation can be doubled if the bearings are relubricated occasionally (refer to the sections *Lubrication*, starting on **page 84** and *Relubrication* on **page 90**)
- Rating life calculations consider the influence of the load and sliding velocity. Under very light loads, and/or low sliding velocities, the result shows relatively long life. The longer the service life the more important is the influence of contaminants such as dirt, moisture and corrosion. Depending on the operating conditions, accurate life calculations may not be possible.

Table 9

Load condition factor b_1 for steel/PTFE FRP sliding contact surface combination

Type of load	Factor b_1	Permissible specific bearing load ¹⁾
–	–	N/mm^2
Constant load²⁾		
Single direction		
GAC .. F	1	up to 50
GX .. F	1	up to 50
GEP .. FS	1	up to 80
GEC .. FBAS	1	up to 80
Variable load		
Alternating direction or pulsating magnitude at a frequency		
up to 0,5 Hz	0,25	up to 40
over 0,5 up to 5 Hz	0,1	up to 25

¹⁾ Inertia forces should also be taken into consideration.

²⁾ For constant load, oscillating frequencies above 300 min^{-1} and very short sliding distances, $b_1 = 1$ cannot be used because of possible material fatigue. For additional information, contact the SKF application engineering service.

Diagram 19

Temperature factor b_2 for steel/PTFE FRP sliding contact surface combination

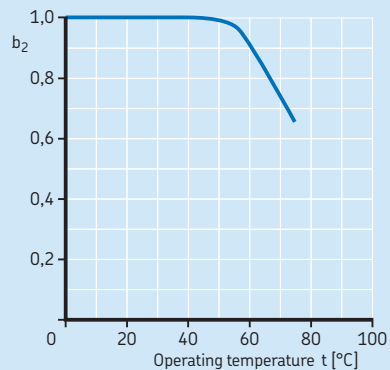

Table 10

Sliding factor b_3 and constant K_M for steel/PTFE FRP sliding contact surface combination

Bearing type Series	Nominal bore diameter d		Sliding factor b_3	Constant K_M
	over	incl.		
–	mm		–	–
Radial bearings				
GEP .. FS	–	180	1	1 055
	180	440	1,15	1 055
	440	–	1,35	1 055
GEC .. FBAS	–	440	1	1 055
	440	–	1,15	1 055
Angular contact bearings¹⁾				
GAC .. F	–	60	1	480
	60	–	1,5	480
Thrust bearings				
GX .. F	–	60	1	670
	60	–	1,5	670
Rod ends			1	530

¹⁾ For preloaded bearings that cannot be re-adjusted, always use $b_3 = 1$.

Variable load and sliding velocity

If the load and/or sliding velocity change during operation, calculate individual rating lives for the periods of constant load and sliding velocity. If the load and sliding velocity occur as shown in **diagram 20a**, the individual basic rating life can be calculated using the constant values of p and v . If the load and sliding velocity are not constant as shown in **diagram 20b**, first calculate the basic rating life for the individual time periods, using mean values for the load and sliding velocity for the individual time periods. Then calculate the total basic rating life using

$$G_h = \frac{1}{\frac{t_I}{T G_{hI}} + \frac{t_{II}}{T G_{hII}} + \frac{t_{III}}{T G_{hIII}} + \dots}$$

where

G_h = total basic rating life, operating hours
 $t_I, t_{II} \dots$ = time during which p_1 and v_1, p_2 and v_2 etc. pertain [h]

T = total duration of one cycle
 (= $t_I + t_{II} + t_{III} + \dots$) [h]

$G_{hI} \dots$ = individual values of basic rating life for conditions p_1 and v_1, p_2 and v_2 etc., operating hours

Diagram 20

Alternating load and variable sliding velocity

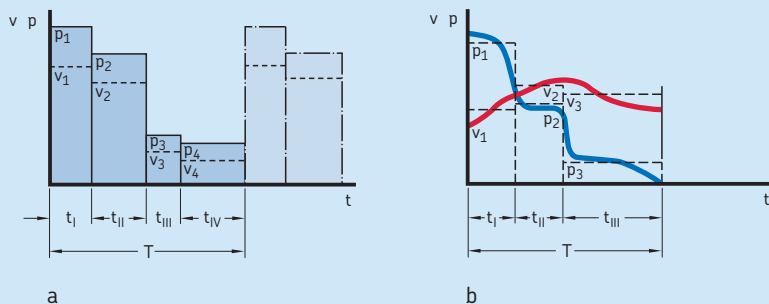

Calculation examples

The following calculation examples illustrate the methods used to determine the requisite bearing size or the basic rating life for spherical plain bearings and rod ends.

1. Torque support of a concrete transporter

Given data

Purely radial load that alternates direction:

$$F_r = 12 \text{ kN}$$

Half angle of oscillation: $\beta = 15^\circ$

(→ fig. 3 on page 39)

Frequency of oscillation: $f = 10 \text{ min}^{-1}$

Maximum operating temperature: $+80 \text{ }^\circ\text{C}$

Requirements

The bearing must have a basic rating life of 7 000 h.

Calculations and selection

Because a bearing in this application must accommodate an alternating load, a steel/steel radial spherical plain bearing is the appropriate choice. Relubrication is planned after every 40 hours of operation.

If, for the first check, a guideline value of 2 is used for the load ratio C/P (→ table 3 on page 45), the required basic dynamic load rating C for the bearing is

$$C = 2 P = 24 \text{ kN}$$

Bearing GE 20 ES, with a $C = 30 \text{ kN}$ and a sphere diameter $d_k = 29 \text{ mm}$, is chosen from the product table on page 104.

To check the suitability of the bearing using the p_v diagram (→ diagram 5 on page 46), calculate the specific bearing load using $K = 100$ from table 4 on page 45.

$$p = K \frac{P}{C} = 100 \times \frac{12}{30} = 40 \text{ N/mm}^2$$

and the sliding velocity v using $d_m = d_k = 29 \text{ mm}$, $\beta = 15^\circ$ and $f = 10 \text{ min}^{-1}$

$$v = 5,82 \times 10^{-7} d_m \beta f$$

$$= 5,82 \times 10^{-7} \times 29 \times 15 \times 10 = 0,0025 \text{ m/s}$$

The values for p and v lie within the permissible operating range I of the p_v diagram (→ diagram 5 on page 46), for steel/steel radial spherical plain bearings. To calculate the basic rating life for initial lubrication, the values that apply are

$b_1 = 2$ (alternating direction load)

$b_2 = 1$ (operating temperature $< 120 \text{ }^\circ\text{C}$
from table 5 on page 52)

$b_3 = 1,5$ (from diagram 11 on page 51,
for $d_k = 29 \text{ mm}$)

$b_4 = 1,1$ (from diagram 12 on page 52,
for $v = 0,0025 \text{ m/s}$)

$b_5 = 3,7$ (from diagram 13 on page 52,
for $\beta = 15^\circ$)

$p = 40 \text{ N/mm}^2$

$v = 0,0025 \text{ m/s}$

Therefore

$$G_h = b_1 b_2 b_3 b_4 b_5 \frac{330}{p^{2,5} v}$$

$$= 2 \times 1 \times 1,5 \times 1,1 \times 3,7 \times \frac{330}{40^{2,5} \times 0,0025}$$

$$\approx 160 \text{ operating hours}$$

The basic rating life of the bearing that is relubricated regularly can now be calculated using

$f_\beta = 5,2$ (from diagram 14 on page 53)

$f_H = 1,8$ (from diagram 15 on page 53, for a relubrication frequency $H = G_h/N = 160/40 = 4$ with the relubrication interval of 40 h)

$$G_{hN} = G_h f_\beta f_H = 160 \times 5,2 \times 1,8$$

$$\approx 1\,500 \text{ operating hours}$$

Because this life is shorter than the required rating life of 7 000 h, a larger bearing is chosen and calculations are repeated.

Bearing GE 25 ES, with $C = 48$ kN and $d_k = 35,5$ mm, is chosen. The values for the specific bearing load lie within the permissible operating range I of the pv diagram (→ **diagram 5** on **page 46**)

$$p = 100 \times \frac{12}{48} = 25 \text{ N/mm}^2$$

and the sliding velocity is

$$v = 5,82 \times 10^{-7} \times 35,5 \times 15 \times 10 = 0,0031 \text{ m/s}$$

As before

$$b_1 = 2, b_2 = 1, b_5 = 3,7$$

and now

$$b_3 = 1,6 \text{ (from **diagram 11** on **page 51**,
for $d_k = 35,5$ mm)}$$

$$b_4 = 1,2 \text{ (from **diagram 12** on **page 52**,
for $v = 0,0031$ m/s)}$$

Therefore, the basic rating life for initial lubrication is

$$G_h = 2 \times 1 \times 1,6 \times 1,2 \times 3,7 \times \frac{330}{25^{2,5} \times 0,0031}$$

$$\approx 480 \text{ operating hours}$$

With $f_B = 5,2$ (from **diagram 14** on **page 53**) and $f_H = 3$ (from **diagram 15** on **page 53** for $H = 480/40 = 12$) the basic rating life for regular relubrication ($N = 40$ h) becomes

$$G_{hN} = 480 \times 5,2 \times 3 = 7\,490 \text{ operating hours}$$

This larger bearing satisfies the rating life requirement.

NOTE: The *SKF Interactive Engineering Catalogue* incorporates programs to perform these and many other calculations quickly and accurately. These programs can be run any number of times to find the best possible solution.

The *SKF Interactive Engineering Catalogue* is available online at www.skf.com.

Selection of bearing size

2. Attachment of a shock absorber of an off-highway vehicle

Given data:

Radial load: $F_r = 7 \text{ kN}$

Axial load: $F_a = 0,7 \text{ kN}$

Half angle of oscillation: $\beta = 8^\circ$ (→ **fig. 3** on **page 39**)

Frequency of oscillation: $f = 15 \text{ min}^{-1}$

Load frequency: 2–5 Hz

Maximum operating temperature: $+75 \text{ }^\circ\text{C}$

Requirements:

This bearing must have a basic rating life corresponding to a driven distance of 100 000 km at an average speed of 65 km/h without maintenance.

Calculations and selection

For design reasons, a GE 20 C spherical plain bearing with a steel/PTFE sintered bronze sliding contact surface combination is proposed.

From the product **table** on **page 132**, the basic dynamic load rating $C = 31,5 \text{ kN}$ and the sphere diameter $d_k = 29 \text{ mm}$ are obtained.

First, the equivalent dynamic bearing load must be determined by

$$F_a/F_r = 0,7/7 = 0,1$$

From **diagram 2** on **page 42** factor $y = 1,4$. The equivalent dynamic bearing load is therefore

$$P = y F_r = 1,4 \times 7 = 9,8 \text{ kN}$$

To check the suitability of the bearing size using the **pv diagram 7** on **page 48**, calculate the values for the specific bearing load (using $K = 100$ from **table 4** on **page 45**) using

$$p = K \frac{P}{C} = 100 \times \frac{9,8}{31,5} = 31 \text{ N/mm}^2$$

and the sliding velocity ($d_m = d_k = 29 \text{ mm}$).

$$v = 5,82 \times 10^{-7} \text{ dm } \beta f$$

$$= 5,82 \times 10^{-7} \times 29 \times 8 \times 15 = 0,002 \text{ m/s}$$

The values for p and v lie within the permissible operating range I of the pv diagram where

$b_1 = 0,2$ (from **table 6** on **page 54**, for a load frequency over 0,5 Hz and $25 < p < 40 \text{ N/mm}^2$)

$b_2 = 1$ (from **diagram 16** on **page 55**, for temperatures $< 80 \text{ }^\circ\text{C}$)

The basic rating life for a GE 20 C bearing with the steel/PTFE sintered bronze sliding contact surface combination is

$$G_h = b_1 b_2 \frac{1\,400}{p^{1,3} v}$$
$$= 0,2 \times 1 \times \frac{1\,400}{31^{1,3} \times 0,002}$$

$$\approx 1\,600 \text{ operating hours}$$

This basic rating life corresponds to a distance (at an average speed of 65 km/h) of $1\,600 \times 65 = 104\,000 \text{ km}$. Therefore, the bearing satisfies the rating life requirement.

3. A 320-bar hydraulic cylinder on a fully automatic press for building industry waste

Given data

Radial load (constant direction)

Operation case	Load F_r	Time period t
I	300 kN	10%
II	180 kN	40%
III	120 kN	50%

The number of press cycles $n = 30$ per hour, and the movement between the end positions (90°) is made in 10 seconds. The operating temperature is less than $+50^\circ\text{C}$.

Requirements

A maintenance-free radial spherical plain bearing with a steel/PTFE fabric sliding contact surface combination is required for a rating life of 5 years with 70 h of operation per week.

Calculations and selection

Using a guideline value for the load ratio $C/P = 2$ (\rightarrow **table 3 on page 45**), and with $P = F_{rI}$ the required basic dynamic load rating

$$C = 2 P = 2 \times 300 = 600 \text{ kN}$$

From the product **table on page 136**, a GE 60 TXE-2LS bearing with a basic dynamic load rating $C = 695 \text{ kN}$ and a sphere diameter $d_k = d_m = 80 \text{ mm}$ is chosen.

First, it is necessary to check that the operation cases I to III fall within the permissible range of the **pv diagram 8 on page 49**.

The sliding velocity is the same for all three cases. The angle of oscillation is specified as 2β , the time t as the time taken to pass through 2β in seconds. Complete cycle duration is 4β (\rightarrow **fig 3 on page 39**).

$$v = 8,73 \times 10^{-6} d_m \frac{2\beta}{t}$$

$$= 8,73 \times 10^{-6} \times 80 \times \frac{90}{10} = 0,0063 \text{ m/s}$$

The specific bearing load, $p = K(P/C)$, using $K = 300$ from **table 4 on page 45**, is

for case I

$$p_I = K \frac{P}{C} = 300 \times \frac{300}{695} = 129,5 \text{ N/mm}^2$$

for case II

$$p_{II} = K \frac{P}{C} = 300 \times \frac{180}{695} = 77,7 \text{ N/mm}^2$$

for case III

$$p_{III} = K \frac{P}{C} = 300 \times \frac{120}{695} = 51,8 \text{ N/mm}^2$$

The values for p_I , p_{II} , p_{III} and v are within the permissible range I of the **pv diagram 8 on page 49**.

To make the lifetime estimate for variable loads and/or sliding velocities, the calculation of each load case has to be made separately, with the equation for TX bearings first

$$G_n = b_1 b_2 b_4 \frac{K_p}{p^n v}$$

The parameters b_1 , b_2 , b_4 , K_p and n are defined on **page 56** and are as follows

$b_1 = 1$ (from **table 7 on page 57**, constant load)
 $b_2 = 1$ (from **diagram 17 on page 56**, operating temperature $< +50^\circ\text{C}$)

$b_4 =$ (from **diagram 18 on page 58**)

$$b_{4I} = 0,31$$

$$b_{4II} = 0,48$$

$$b_{4III} = 0,57$$

$K_p =$ (from **table 8 on page 57**)

$$K_{pI} = 40\,000$$

$$K_{pII} = 4\,000$$

$$K_{pIII} = 4\,000$$

$n =$ (from **table 8 on page 57**)

$$n_1 = 1,2$$

$$n_2 = 0,7$$

$$n_3 = 0,7$$

Selection of bearing size

for case I

$$G_{hI} = 1 \times 1 \times 0,31 \times \frac{40\,000}{129,5^{1,2} \times 0,0063}$$

= 5 745 operating hours

for case II

$$G_{hII} = 1 \times 1 \times 0,48 \times \frac{4\,000}{77,7^{0,7} \times 0,0063}$$

= 14 477 operating hours

for case III

$$G_{hIII} = 1 \times 1 \times 0,57 \times \frac{4\,000}{51,8^{0,7} \times 0,0063}$$

= 22 833 operating hours

Using the calculated basic rating lives of the three operation cases, the total basic rating life for continuous operation is (→ page 61)

$$G_h = \frac{1}{\frac{t_I}{T G_{hI}} + \frac{t_{II}}{T G_{hII}} + \frac{t_{III}}{T G_{hIII}}}$$

For t_I , t_{II} etc., the percentages given in the operating data are inserted (with $T = t_I + t_{II} + t_{III} = 100\%$.)

$$G_h = \frac{1}{\frac{10}{100 \times 5\,745} + \frac{40}{100 \times 14\,477} + \frac{50}{100 \times 22\,833}}$$

≈ 14 940 operating hours

The required life of five years should be met assuming the machine is operated 70 h/week, 30 cycles/hour and 50 weeks per year, to 525 000 cycles or 2 916 operating hours. (Note that time for a complete cycle is 20 s.)

$$G_{N, \text{Req}} = 5 \times 70 \times 30 \times 50 = 525\,000 \text{ cycles}$$

$$G_{h, \text{Req}} = (525\,000 \times 20) / 3600 = 2\,916 \text{ h.}$$

4. Linkages of a conveyor installation

Given data

Radial load of alternating direction: $F_r = 5,5 \text{ kN}$
 Half angle of oscillation: $\beta = 15^\circ$ (→ **fig. 3** on **page 39**)

Frequency of oscillation: $f = 25 \text{ min}^{-1}$

Operating temperature: $+70 \text{ }^\circ\text{C}$

Requirements

A rod end is needed that provides a basic rating life of 9 000 hours under alternating load conditions.

Calculations and selection

Because the load is alternating, a steel/steel rod end is appropriate. Relubrication is planned every 40 hours of operation. Using the guideline value for the load ratio $C/P = 2$ from **table 3** on **page 45**, and as $P = F_r$, the requisite basic dynamic load rating is

$$C = 2P = 2 \times 5,5 = 11 \text{ kN}$$

The SI 15 ES rod end with a basic dynamic load rating $C = 17 \text{ kN}$ is selected (→ **page 172**). The basic static load rating is $C_0 = 37,5 \text{ kN}$ and the sphere diameter $d_k = 22 \text{ mm}$.

To check the suitability of rod end size using the p_v **diagram 5** on **page 46**, calculate the values for the specific bearing load (using $K = 100$ from **table 4** on **page 45**)

$$p = K \frac{P}{C} = 100 \times \frac{300}{695} = 32,4 \text{ N/mm}^2$$

and the mean sliding velocity ($d_m = d_k = 22 \text{ mm}$)

$$v = 5,82 \times 10^{-7} d_k \beta f$$

$$= 5,82 \times 10^{-7} \times 22 \times 15 \times 25 = 0,0048 \text{ m/s}$$

The values for p and v lie within the permissible range I of the p_v **diagram 5** on **page 46**.

Checking the permissible load on the rod end housing

$$\begin{aligned} C_0 &= 37,5 \text{ kN} \\ b_2 &= 1 \text{ (from table 5 on page 52,} \\ &\text{for temperatures } < 120 \text{ }^\circ\text{C)} \\ b_6 &= 0,35 \text{ (from table 2 on page 44,} \\ &\text{for rod ends with a lubrication hole)} \end{aligned}$$

$$\begin{aligned} P_{\text{perm}} &= C_0 b_2 b_6 \\ &= 37,5 \times 1 \times 0,35 \\ &= 13,125 \text{ kN} > P \end{aligned}$$

The following values of the factors are used to determine the basic rating life for initial lubrication only

$$\begin{aligned} b_1 &= 2 \text{ (alternating load)} \\ b_2 &= 1 \text{ (for operating temperatures } < 120 \text{ }^\circ\text{C,} \\ &\text{from table 5 on page 52)} \\ b_3 &= 1,3 \text{ (from diagram 11 on page 51,} \\ &\text{for } d_k = 22 \text{ mm)} \\ b_4 &= 1,6 \text{ (from diagram 12 on page 52,} \\ &\text{for } v = 0,0048 \text{ m/s)} \\ b_5 &= 3,7 \text{ (from diagram 13 on page 52,} \\ &\text{for } \beta = 15^\circ) \\ p &= 32 \text{ N/mm}^2 \\ v &= 0,0048 \text{ m/s} \end{aligned}$$

Therefore

$$\begin{aligned} G_h &= b_1 b_2 b_3 b_4 b_5 \frac{330}{32,4^{2,5} \times 0,0048} \\ &= 2 \times 1 \times 1,3 \times 1,6 \times 3,7 \times \frac{330}{32,4^{2,5} \times 0,0048} \end{aligned}$$

$$\approx 177 \text{ operating hours}$$

The basic rating life for regular relubrication ($N = 40 \text{ h}$) with

$$\begin{aligned} f_\beta &= 5,2 \text{ (from diagram 14 on page 53) and} \\ f_H &= 2 \text{ (from diagram 15 on page 53,} \\ &\text{for } H = G_h/N = 177/40 = 4,4) \\ G_{hN} &= G_h f_\beta f_H = 177 \times 5,2 \times 2 \end{aligned}$$

$$\approx 1840 \text{ operating hours}$$

Selection of bearing size

The required basic rating life of 9 000 h is not achieved; therefore a larger rod end has to be selected. A SI 20 ES rod end, with $C = 30$ kN, $C_0 = 57$ kN and $d_k = 29$ mm is selected and the calculation repeated.

The values for the specific bearing load

$$p = K \frac{P}{C} = 100 \times \frac{5,5}{30} = 18,3 \text{ N/mm}^2$$

and the mean sliding velocity ($d_m = d_k = 29$ mm)

$$v = 5,82 \times 10^{-7} \times 29 \times 15 \times 25 = 0,0063 \text{ m/s}$$

both lie within the permissible range I. It is not necessary to check the permissible rod end housing load since the basic static load rating of the larger rod end is higher. Also, as before

$$b_1 = 2; b_2 = 1 \text{ and } b_5 = 3,7$$

while

$$b_3 = 1,4 \text{ (from diagram 11 on page 51, for } d_k = 29 \text{ mm)}$$

$$b_4 = 1,8 \text{ (from diagram 12 on page 52, for } v = 0,0063 \text{ m/s)}$$

so that

$$G_h = 2 \times 1 \times 1,4 \times 1,8 \times 3,7 \times \frac{330}{18,3^{2,5} \times 0,0063}$$

$$\approx 681 \text{ operating hours}$$

With $f_B = 5,2$ (from **diagram 14** on **page 53**) and $f_H = 3,7$ (from **diagram 15** on **page 53**, for $H = 681/40 \approx 17$) the basic rating life for regular relubrication ($N = 40$ h) becomes

$$G_{hN} = 681 \times 5,2 \times 3,7$$

$$\approx 13\,100 \text{ operating hours}$$

Therefore, the larger rod end meets the rating life requirements.

Friction

The friction in a spherical plain bearing or rod end depends primarily on the sliding contact surface combination, the load and the sliding velocity. Because there are so many influencing factors that are not mutually independent, it is not possible to quote exact values for the coefficient of friction. Under laboratory conditions, however, it is possible to record the coefficient of friction for different sliding contact surface combinations. The friction during the running-in phase is higher than the value recorded during the subsequent test period.

Guideline values for the coefficient of friction μ are listed in **table 1**. They have been determined in laboratory trials.

The coefficient of friction for maintenance-free steel/PTFE fabric and steel/PTFE sintered bronze sliding contact surface combinations decrease with increasing specific load. At a constant specific load, friction is reduced to the given minimum value as soon as the transfer of PTFE from the sliding layer to the opposing steel surface is complete. The frictional moment for a spherical plain bearing or rod end can be calculated using

$$M = 0,5 \mu P d_m$$

where

M = frictional moment [Nm]

μ = coefficient of friction (\rightarrow **table 1**)

P = equivalent dynamic bearing load [kN]

d_m = inner ring mean diameter [mm]

$d_m = d_k$ for radial spherical plain bearings and rod ends

$d_m = 0,9 d_k$ for angular contact spherical plain bearings

$d_m = 0,7 d_k$ for thrust spherical plain bearings

d_k = inner ring sphere diameter [mm]

Table 1

Coefficient of friction for different sliding contact surface combinations (guideline values)

Sliding contact surface combination	Coefficient of friction μ	
	min	max
Steel/steel	0,08	0,20
Steel/bronze	0,10	0,25
Steel/PTFE sintered bronze	0,05	0,25
Steel/PTFE fabric	0,02	0,15
Steel/PTFE FRP	0,05	0,20

After the bearing has been in operation for an extended period of time, negative influences (contamination, inadequate lubrication) may cause the bearing to approach or exceed the maximum values for the coefficient of friction listed in the table. Bearings are susceptible to this phenomenon even under light loads and especially under harsh operating conditions. In applications where friction is particularly important, SKF recommends determining the power ratings by using the maximum values for the coefficient of friction that are listed in **table 1**. For bearings operating under conditions of mixed or dry friction, there may be slight differences between adhesive and sliding friction. Experience has shown that it is not possible to eliminate stick-slip entirely and that it most frequently occurs when support elements lack adequate stiffness. In most applications, however, the effects are negligible.

Design of bearing arrangements

Radial location of bearings

The inner and outer rings of spherical plain bearings must be radially secured (located) to the shaft and in the housing so that sliding movements occur in the bearing and do not result in ring creep. Ring creep occurs when a ring turns on its seat in the circumferential direction under load. To locate a bearing in the radial direction usually requires an interference fit. However, an interference fit cannot always be applied, e.g. if easy mounting and dismounting are required, or if the bearing must be able to be displaced axially without restraint.

The appropriate fit is always determined by the operating conditions.

1. Type and magnitude of the load

The degree of interference must suit the type and magnitude of the load, i.e. the heavier the load and the stronger the shock loads, the tighter the interference required (→ **fig. 1**).

- Under heavy loads, spherical plain bearings deform elastically, which may affect the interference fit and lead to ring creep.
- The strength of the associated components must be adequate to accommodate the loads and fully support the bearing.
- If the associated components deform, there is a risk that through-hardened bearing rings crack.
- Steel/steel radial spherical plain bearings require a tighter fit than comparable maintenance-free bearings, which have a lower coefficient of friction.

2. Bearing internal clearance

An interference fit on the shaft and in the housing causes the inner ring to expand elastically, and the outer ring to be compressed elastically.

This reduces the initial internal clearance in the bearing, prior to operation. The operating clearance (→ **fig. 2**) furthermore takes the load and operating temperature into consideration.

The initial radial internal clearance of bearings differs, depending on the type and size of the bearing. The clearance has been selected so that if the recommended tolerances for the shaft and housing seats are applied, an appropriate operating clearance (or preload) remains in the bearing under normal operating conditions.

If a tight interference fit is used for both bearing rings, or if the operating temperatures are unusual, it may be necessary to use a larger initial internal clearance than “Normal” for steel/steel bearings.

3. Temperature conditions

In operation, the bearing rings normally have a higher temperature than their seats. This means that

- the inner ring fit gets looser (→ **fig. 3**)
- the outer ring fit becomes tighter and may restrict any required axial displacement in the housing.

If there is a considerable temperature difference between the inner ring and outer ring, there is a change in the operating clearance. This condition must be considered when selecting the fit or the bearing could seize, making it difficult or impossible for the shaft to turn.

Fig. 1

For heavier loads a tighter interference fit is needed

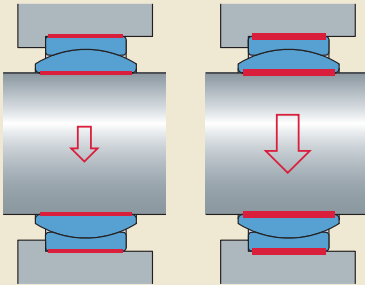

4. Design of associated components

The bearing seats on the shaft and in the housing must not lead to uneven distortion (out-of-round) of the bearing rings (→ fig. 4). Therefore:

- Split housings are not suitable for interference fits.
- Thin-walled housings, light alloy housings and hollow shafts require a tighter fit than thick-walled steel or cast iron housings and solid shafts – and must have sufficient strength.
- Heavy loads and interference fits require thick-walled one-piece steel or cast iron housings and solid steel shafts.

Fig. 2

Reduction of the clearance in the bearing

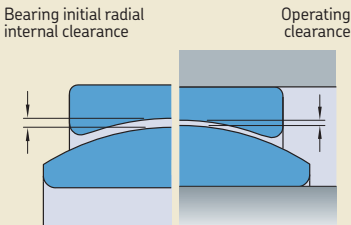

Fig. 3

Change to the fit with temperature

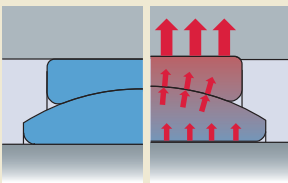
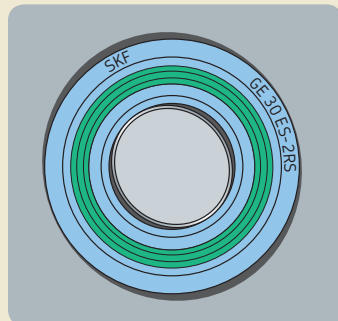

Fig. 4

Out-of-round bearing seat



Design of bearing arrangements

5. Axial displacement of non-locating bearings

A non-locating bearing provides radial support only and must always be able to be displaced axially (→ **fig. 5**). This is normally achieved by selecting a loose fit for one of the bearing rings, generally the inner ring of a spherical plain bearing. Reasons include the following:

- The shaft seat can be easily and economically hardened and ground to facilitate axial displacement. The hardness of the shaft should be at least 50 HRC.
- The outer rings of most spherical plain bearings are axially fractured at one or two positions, or are radially split. This can make axial displacement difficult, if not impossible.
- The housing bore should be protected against wear.

Surface finish of seats

The recommended surface roughness for bearing seats is in accordance with ISO 4288:1997.

- for shaft seats $R_z \leq 10 \mu\text{m}$
- for housing bore seats $R_z \leq 16 \mu\text{m}$

Recommended fits

Only a limited number of ISO tolerance classes are appropriate for spherical plain bearings.

Fig. 6 shows schematically the relative positions of these in relation to the bore and outside diameter of the bearings. The recommended tolerance classes for

- the shaft seat are provided in **table 1**
- the housing bore are provided in **table 2**

These recommendations are based on the considerations described above and have been confirmed in a wide variety of bearing applications. The ISO tolerance limits are listed in

- **table 3** on **page 74** for shafts
- **table 4** on **page 74** for housing bores

To facilitate the calculation of the minimum and maximum values of the theoretical interference or clearance, the standardized bearing bore diameter deviations (Δ_{dmp}) and the bearing outside diameter deviations (Δ_{Dmp}) are listed in **tables 3** and **4**.

Fig. 5

Axial displacement

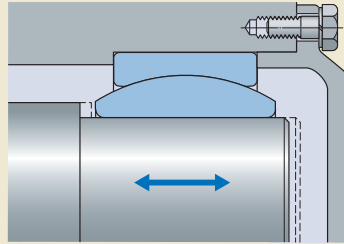

Fig. 6

ISO shaft and housing tolerance classes

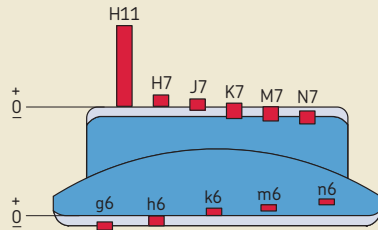

Table 1

Shaft fits

Operating conditions	Tolerance classes	
	Sliding contact surface combination	
	steel/steel and steel/bronze	steel/PTFE sintered bronze, steel/PTFE fabric and steel/PTFE FRP
Radial spherical plain bearings		
Loads of all kinds, interference fit	m6 (n6) ¹⁾	k6
Loads of all kinds, clearance or transition fit	h6 (hardened shaft)	h6 or g6 (hardened shaft)
Angular contact spherical plain bearings		
Loads of all kinds, interference fit	m6 (n6)	m6
Thrust spherical plain bearings		
Loads of all kinds, interference fit	m6 (n6)	m6

The tolerance classes in brackets should be selected for very heavily loaded bearings. If selected, be sure that the residual operating clearance is sufficient for proper performance of the bearing or whether a bearing with larger clearance must be used.

¹⁾ These recommendations do not apply to bearings in the GEG series, which have a bore diameter tolerance class to H7 and are normally mounted on shaft seats machined to tolerance class m7. If, for mounting reasons, the shaft is machined to tolerance class f7, it should be hardened as movements of the shaft relative to the bearing bore take place and wear may result.

Table 2

Housing fits

Operating conditions	Tolerance classes	
	Sliding contact surface combination	
	steel/steel	steel/PTFE sintered bronze, steel/PTFE fabric and steel/PTFE FRP
Radial spherical plain bearings		
Light loads, axial displacement required	H7	H7
Heavy loads	M7 (N7)	K7
Light alloy housings	N7	M7
Angular contact spherical plain bearings		
Loads of all kinds, interference fit	M7 (N7)	M7
Loads of all kinds, can generally be displaced axially	J7	J7
Thrust spherical plain bearings		
Purely axial loads	H11	H11
Combined loads	J7	J7

The tolerance classes in brackets should be selected for very heavily loaded bearings. If selected, be sure that the residual operating clearance of the radial bearing is sufficient for proper performance or whether a bearing with larger clearance must be used.

Table 3

ISO tolerance classes for shafts

Shaft Nominal diameter		Bearing Bore diameter tolerance		Shaft diameter deviations Tolerance classes									
d over	incl.	Δ_{dmp} low	high	g6 high	low	h6 high	low	k6 high	low	m6 high	low	n6 high	low
mm		μm		μm									
3	6	-8	0	-4	-12	0	-8	+9	+1	+12	+4	+16	+8
6	10	-8	0	-5	-14	0	-9	+10	+1	+15	+6	+19	+10
10	18	-8	0	-6	-17	0	-11	+12	+1	+18	+7	+23	+12
18	30	-10	0	-7	-20	0	-13	+15	+2	+21	+8	+28	+15
30	50	-12	0	-9	-25	0	-16	+18	+2	+25	+9	+33	+17
50	80	-15	0	-10	-29	0	-19	+21	+2	+30	+11	+39	+20
80	120	-20	0	-12	-34	0	-22	+25	+3	+35	+13	+45	+23
120	180	-25	0	-14	-39	0	-25	+28	+3	+40	+15	+52	+27
180	250	-30	0	-15	-44	0	-29	+33	+4	+46	+17	+60	+31
250	315	-35	0	-17	-49	0	-32	+36	+4	+52	+20	+66	+34
315	400	-40	0	-18	-54	0	-36	+40	+4	+57	+21	+73	+37
400	500	-45	0	-20	-60	0	-40	+45	+5	+63	+23	+80	+40
500	630	-50	0	-22	-66	0	-44	+44	0	+70	+26	+88	+44
630	800	-75	0	-24	-74	0	-50	+50	0	+80	+30	+100	+50
800	1 000	-100	0	-26	-82	0	-56	+56	0	+90	+34	+112	+56
1 000	1 250	-125	0	-28	-94	0	-66	+66	0	+106	+40	+132	+66

Table 4

ISO tolerance classes for housings

Housing Nominal bore diameter		Bearing Outside diameter tolerance		Housing bore diameter deviations Tolerance classes											
d over	incl.	Δ_{Dmp} high	low	H11 low	high	H7 low	high	J7 low	high	K7 low	high	M7 low	high	N7 low	high
mm		μm		μm											
10	18	0	-8	0	+110	0	+18	-8	+10	-12	+6	-18	0	-23	-5
18	30	0	-9	0	+130	0	+21	-9	+12	-15	+6	-21	0	-28	-7
30	50	0	-11	0	+160	0	+25	-11	+14	-18	+7	-25	0	-33	-8
50	80	0	-13	0	+190	0	+30	-12	+18	-21	+9	-30	0	-39	-9
80	120	0	-15	0	+220	0	+35	-13	+22	-25	+10	-35	0	-45	-10
120	150	0	-18	0	+250	0	+40	-14	+26	-28	+12	-40	0	-52	-12
150	180	0	-25	0	+250	0	+40	-14	+26	-28	+12	-40	0	-52	-12
180	250	0	-30	0	+290	0	+46	-16	+30	-33	+13	-46	0	-60	-14
250	315	0	-35	0	+320	0	+52	-16	+36	-36	+16	-52	0	-66	-14
315	400	0	-40	0	+360	0	+57	-18	+39	-40	+17	-57	0	-73	-16
400	500	0	-45	0	+400	0	+63	-20	+43	-45	+18	-63	0	-80	-17
500	630	0	-50	0	+440	0	+70	-	-	-70	0	-96	-26	-114	-44
630	800	0	-75	0	+500	0	+80	-	-	-80	0	-110	-30	-130	-50
800	1 000	0	-100	0	+560	0	+90	-	-	-90	0	-124	-34	-146	-56
1 000	1 250	0	-125	0	+660	0	+105	-	-	-105	0	-145	-40	-171	-66
1 250	1 600	0	-160	0	+780	0	+125	-	-	-125	0	-173	-48	-203	-78
1 600	2 000	0	-200	0	+920	0	+150	-	-	-150	0	-208	-58	-242	-92

Axial location of bearings

Locating bearings

An interference fit alone is not sufficient to axially locate a bearing ring. It is usually necessary to use a suitable locking device to secure the ring in place.

Both rings of a locating bearing should be located axially on both sides. The bearing rings generally have an interference fit and are usually supported on one side by a shaft or housing shoulder. Inner rings are axially secured on the opposite end by

- a plate bolted to the shaft end (→ **fig. 7**)
- a spacer sleeve between the ring and a neighbouring machine component (→ **fig. 8**)
- a retaining ring (circlip)

Outer rings are generally retained by the cover of the housing bore (→ **figs. 7 and 8**).

Non-locating bearings

For non-locating bearings, the outer ring (which normally has a tight fit) is axially located while the inner ring is free to move axially on the shaft (→ **fig. 5 on page 72**).

Note that for bearings in the GEP series (→ **fig. 9**), which have a radially split outer ring, expansion forces are produced under purely radial load; the axial components of these forces act on the housing cover. The axial load acting on the cover may be as much as 30% of the radial load. This must be taken into account when

Fig. 7

Using an end plate and cover to locate a bearing axially

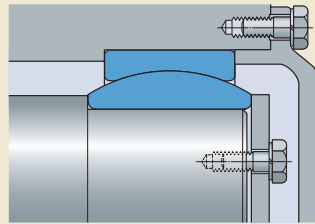

Fig. 8

Using a spacer sleeve and cover to locate a bearing axially

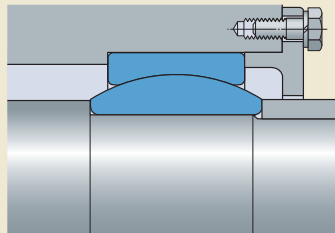
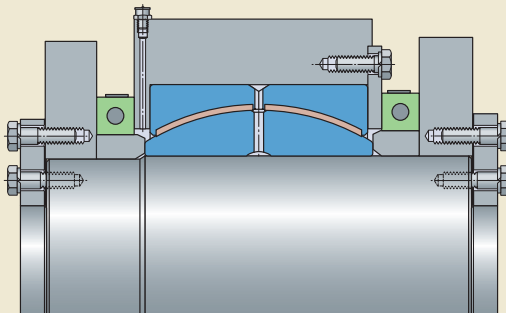

Fig. 9

Locating a radial spherical plain bearing having a radially split outer ring



Design of bearing arrangements

dimensioning the housing cover and selecting the size and number of the attachment bolts.

If shaft and/or housing shoulders are undesirable because of manufacturing or assembly considerations, spacer sleeves or rings can be inserted between a bearing ring and an adjacent machine component (→ **figs. 10** and **11**).

Axially locating a non-separable bearing with locating rings (→ **figs. 10** and **11**) saves space, enables quick mounting and dismounting and simplifies the machining of the seats. If larger axial forces have to be accommodated, a support ring (→ **fig. 11**) should be placed between the bearing ring and the locating ring, so that the locating ring is not subjected to excessive bending moments.

To locate the bearing, retaining rings (also known as circlips) with a constant radial width in accordance with DIN 471:1981 or DIN 472:1981 can be used.

Fig. 10

Locating a bearing axially, using retaining rings in the housing and adjacent components on the shaft

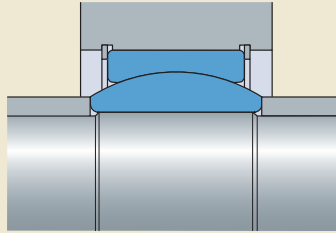

Fig. 11

Locating a bearing axially, using adjacent components in the housing and a support ring and a retaining ring on the shaft

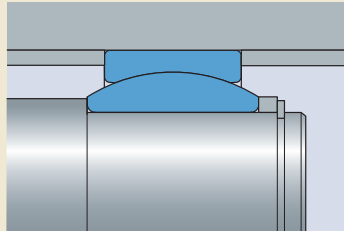

Fig. 12

Shaft and housing abutment dimensions

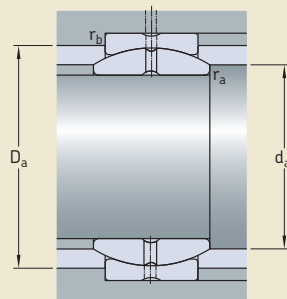
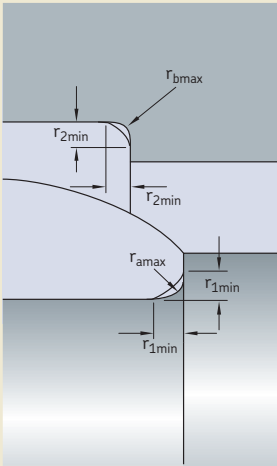

Fig. 13

Shaft and housing fillet dimensions, no undercut



Abutment and fillet dimensions

The abutment and fillet dimensions should be such that:

- A sufficiently large support surface is available for the bearing ring.
- Moving parts of the bearing arrangement cannot contact stationary components.
- The fillet radius should be smaller than the chamfer of the bearing.

Appropriate abutment dimensions (→ fig. 12) are provided for each bearing in the product tables. The transition from the bearing seat to the shaft or housing shoulder can be either a simple fillet (→ fig. 13) or an undercut (→ fig. 14). Dimensions for r_{amax} and r_{bmax} are listed in the product tables.

Dimensions for undercuts are provided in table 5.

The larger the fillet radius (for the simple form) of the transition to the shaft shoulder, the more favourable is the stress distribution in the shaft fillet area.

Fig. 14

Shaft and housing fillet dimensions, with an undercut

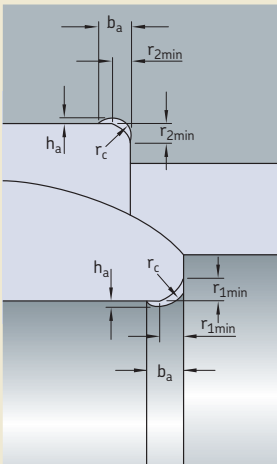

Table 5

Undercut dimensions

Chamfer dimensions r_{1min}, r_{2min}	Fillet dimensions		
	b_a	h_a	r_c
mm	mm		
1	2	0,2	1,3
1,1	2,4	0,3	1,5
1,5	3,2	0,4	2
2	4	0,5	2,5
2,5	4	0,5	2,5
3	4,7	0,5	3
4	5,9	0,5	4
5	7,4	0,6	4
6	8,6	0,6	6
7,5	10	0,6	7

Location of rod ends

The inner rings of rod ends can be axially located by a shaft shoulder, a nut or a retaining ring.

Rod ends mounted on threaded rods or in extension tubes should be secured by an extra nut on the rod or the external thread of the rod end shank. The nut should be securely tightened against the support surface on the rod end housing or on the tube (→ **fig. 15**).

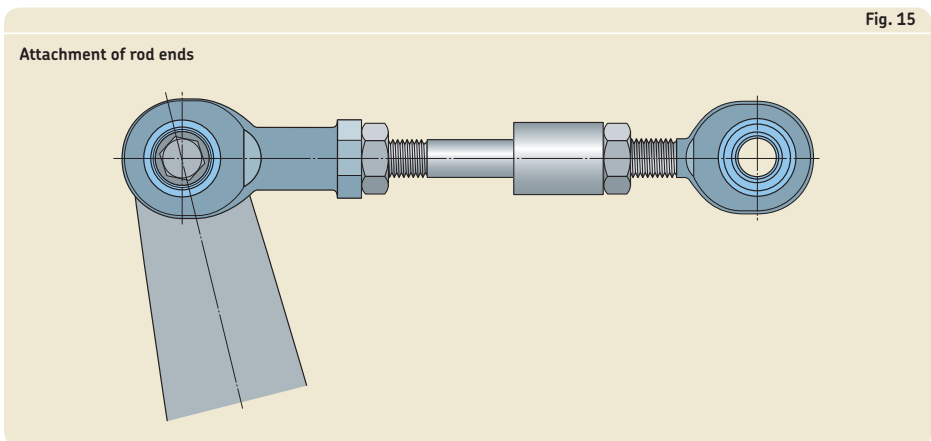

Sealing

Most bearing arrangements must be sealed to prevent contaminants, such as dirt and moisture, from entering the bearing. The efficiency of the seal has a decisive influence on the service life of the bearing. In contrast to most other bearing types, which only move in one plane, the alignment capabilities of spherical plain bearings place additional demands on the seal.

To select appropriate seals, several factors have to be considered, including:

- the permissible angle of tilt
- the available space
- environmental conditions
- the effectiveness of the seal
- the type of lubricant and the frequency of relubrication
- the justifiable cost

Depending on the application, one or more of the above factors outweigh the others. It is therefore not possible to establish general rules for seal design.

Most SKF radial spherical plain bearing series are available with integral seals. Standard sealed bearings can increase the service life of the bearings and save space, while reducing

inventory and assembly costs. Design characteristics and suitability of the RS seals and the LS heavy-duty seals are provided in **table 6**.

Table 7 on **pages 80 to 81**, provides an overview of external sealing possibilities, their design characteristics and their suitability to meet different application requirements. SKF supplies most of the external seals introduced in **table 7**.

NOTE: SKF additional information about the seals referred to in **table 7** on **pages 80 to 81**, refer to the *SKF Interactive Engineering Catalogue*, available online at www.skf.com.

SKF also supplies sealing strips made of felt (FS strips) or aluminium-boron silicate (FSB strips) for high temperature applications.

Table 6

SKF integral seals for spherical plain bearings



Seal	Illustration	Design characteristics	Suitability
RS design		Double-lip contact seal made of <ul style="list-style-type: none"> • polyester elastomer for metric bearings with a bore diameter $d < 320$ mm (-30 to $+130$ °C) • acrylonitrile-butadiene rubber for metric bearings with a bore diameter $d \geq 320$ mm (-35 to $+100$ °C) • polyurethane for inch bearings (-20 to $+80$ °C) 	<ul style="list-style-type: none"> • for compact bearing arrangements, mainly indoors • for cramped spaces • for high sealing demands when combined with an outboard seal • for long service life with minimal maintenance • for arrangements with bearings that rotate
LS design		Triple-lip heavy-duty contact seal made of acrylonitrile-butadiene rubber with sheet steel insert (-55 to $+110$ °C, for short periods up to $+125$ °C)	<ul style="list-style-type: none"> • for compact bearing arrangements • for high sealing demands • for long service life with minimal maintenance • for arrangements with bearings that rotate • for difficult operating conditions in the presence of sand or mud

Table 7

External seals for spherical plain bearings

Seal	Illustration	Design characteristics	Suitability
Gap-type		Simple and economic, no wear, simple mounting	<ul style="list-style-type: none"> • for maintenance-free bearings • for small angles of tilt • for high temperatures • for moderately dusty environments • for arrangements with bearings that rotate
Gap-type with grease		Simple and efficient with periodic relubrication	<ul style="list-style-type: none"> • for bearings and rod ends requiring maintenance • for small angles of tilt • for rough conditions in the presence of sand, clay, slush etc.
V-shaped		<p>Simple, lightly preloaded seal made of polyurethane (-40 to +100 °C)</p> <p>Good wear strength and resistance to grease, oil and other environmental influences</p>	<ul style="list-style-type: none"> • for contaminant exclusion • for angles of tilt up to 2° • for bearing arrangements with shaft diameters up to 300 mm • for arrangements with bearings that rotate
V-ring		<p>Elastic seal that sits on the shaft and turns with it, axial sealing lip made of acrylonitrile-butadiene rubber (-40 to +100 °C) or fluoro rubber (-40 to +200 °C)</p> <p>Good wear and chemical resistance</p>	<ul style="list-style-type: none"> • for contaminant exclusion • for maintenance-free and grease-lubricated bearings • for all shaft diameters • for angles of tilt between 2 and 4°, depending on size • for arrangements with bearings that rotate
Felt		Simple to install, good resistance to grease (-40 to +100 °C)	<ul style="list-style-type: none"> • for dust and minor dampness exclusion • for grease retention • for large angles of tilt • for all bearing sizes • for arrangements with bearings that rotate
Radial shaft		<p>Steel reinforced (either externally or internally) elastomer with a acrylonitrile-butadiene rubber lip (-40 to +100 °C) or fluoro rubber lip (-40 to +200 °C)</p> <p>Good wear resistance, good resistance to grease, oil and other environmental influences</p>	<ul style="list-style-type: none"> • for contaminant exclusion • for grease retention • for oil retention • for small angles of tilt • for all bearing sizes • for arrangements with bearings that rotate

External seals for spherical plain bearings

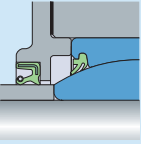
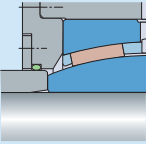
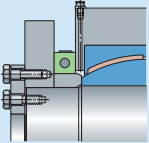
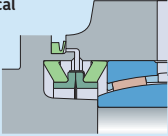
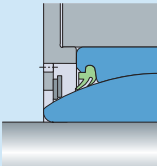
Seal	Illustration	Design characteristics	Suitability
Radial shaft with an auxiliary dust lip		Steel reinforced (either externally or internally) elastomer with an acrylonitrile-butadiene rubber lip (-40 to +100 °C) or fluoro rubber lip (-40 to +200 °C) Good wear resistance, good resistance to grease, oil and other environmental influences	<ul style="list-style-type: none"> • for highly contaminated environments • for oil retention • for small angles of tilt • for bearings with a bore diameter d up to approx. 300 mm • for arrangements with bearings that rotate
O-ring		Acrylonitrile-butadiene rubber (-40 to +100 °C) or fluoro rubber (-40 to +200 °C)	<ul style="list-style-type: none"> • for reliable moisture exclusion • for oil and grease retention • for very small angles of tilt • for slow oscillating movements
Profiled rubber with clamp and lock		Elastomer strip (-40 to +100 °C) Good wear resistance, good resistance to grease, oil and other environmental influences	<ul style="list-style-type: none"> • for hermetically sealed bearing arrangements • for slow oscillating movements. Initial oiling or greasing of faces reduces friction • for small angles of tilt
Mechanical seals		Stainless steel rings and cup springs of acrylonitrile-butadiene rubber (-40 to +100 °C) Good wear resistance, good resistance to grease, oil and other environmental influences	<ul style="list-style-type: none"> • for contaminant exclusion • for oil and grease retention • for small angles of tilt • for arrangements with bearings that rotate
Spring steel washers		Set of washers for high temperatures. Excellent wear resistance, good chemical resistance	<ul style="list-style-type: none"> • for contaminant exclusion • grease exit vents needed in housing cover if grease used • for small angles of tilt • for arrangements with bearings that rotate

WARNING!

Some of the external seals listed in this table can be made of fluoro rubber. Note that fluoro rubber gives off dangerous fumes at temperatures above 300 °C and can be hazardous if touched. As handling seals made of fluoro rubber constitutes a potential safety risk, the safety precautions must always be followed. For detailed information about the safety precautions, refer to the *SKF Interactive Engineering Catalogue*, available online at www.skf.com, the *SKF General Catalogue* or the publication *Industrial shaft seals*.

Designing a bearing arrangement for easy mounting and dismounting

To facilitate mounting, the shaft ends and housing bores should have a 10 to 20 degree lead-in chamfer (→ **fig. 16**). This is particularly important for applications using larger bearings, as the rings may skew, causing damage to the mating surfaces.

To facilitate the use of withdrawal tools when removing bearings, it can be advantageous to:

- provide recesses in the shaft shoulder (→ **fig. 17**)
- provide recesses or threaded holes in the housing bore (→ **fig. 18**)

To dismount larger maintenance-free bearings with a bore diameter $d \geq 80$ mm that have a tight shaft fit, SKF recommends using the oil injection method. With the oil injection method, oil under high pressure is injected between the bearing inner ring and its shaft seat to form an oil film. This oil film separates the mating surfaces, greatly reducing the force required to dismount the bearing and virtually eliminating any risk of damage to the bearing or shaft.

To use the oil injection method, there must be an oil supply duct in the shaft as well as an oil distribution groove in the seat (→ **fig. 19**). As a general rule, the distance between the groove and the bearing side face from which mounting and dismounting are to be performed should be approximately one third of the seat width (→ **fig. 19**). Recommended dimensions for the ducts and grooves as well as for the threads for the oil supply connection are provided in **tables 8** and **9**.

Fig. 16

Chamfering shaft ends and housing bore entrances

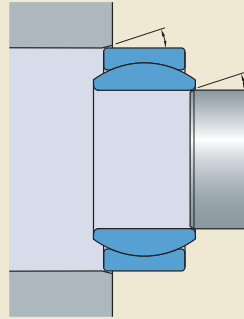

Fig. 17

Shaft shoulder with a recess

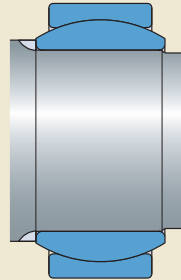

Fig. 18

Housing shoulder with threaded holes

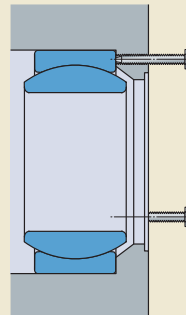
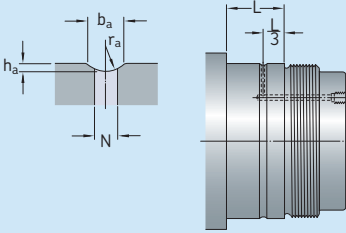

Table 8

Recommended dimensions for oil supply ducts and distribution grooves



Bearing seat diameter		Dimensions			
over	incl.	b_a	h_a	r_a	N
mm		mm			
-	100	3	0,5	2,5	2,5
100	150	4	0,8	3	3
150	200	4	0,8	3	3
200	250	5	1	4	4
250	300	5	1	4	4
300	400	6	1,25	4,5	5
400	500	7	1,5	5	5
500	650	8	1,5	6	6
650	800	10	2	7	7
800	1 000	12	2,5	8	8

L = width of bearing seat.

Table 9

Design and recommended dimensions for threaded holes for connecting oil supply

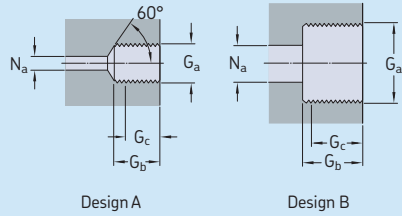

Thread	Design	Dimensions		
		G_b	$G_c^{1)}$	N_a max
-	-	mm		
M6	A	10	8	3
G 1/8	A	12	10	3
G 1/4	A	15	12	5
G 3/8	B	15	12	8
G 1/2	B	18	14	8
G 3/4	B	20	16	8

¹⁾ Effective threaded length.

Fig. 19

Shaft with oil ducts and a distribution groove to facilitate dismounting

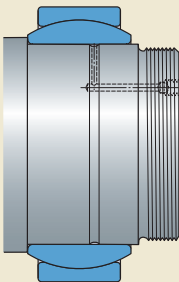

Lubrication

The SKF traffic light concept

Most grease suppliers indicate the specific values for the low and high temperature limits in their product information. The SKF traffic light concept is distinctly different from that. SKF recognizes that the really important temperatures for reliable operation lie within a smaller range. This range depends largely on the type of base oil and thickener used as well as the additives. The relevant temperatures are given by the SKF traffic light concept. They are schematically illustrated in **diagrams 1** and **2** in the form of a double traffic light.

It is evident that grease in the red zones should not be applied at all, as damage may occur. Within the green zone the grease functions reliably, and the grease life can be determined accurately.

At temperatures in the amber zone above the high temperature performance limit (HTPL), grease ages and oxidize with increasing rapidity and the by-products of the oxidation have a detrimental effect on lubrication. An amber zone also exists for low temperatures. Short periods in this zone, e.g. during a cold start, are not harmful since the heat caused by friction brings the bearing temperature into the green zone.

The SKF traffic light concept – general

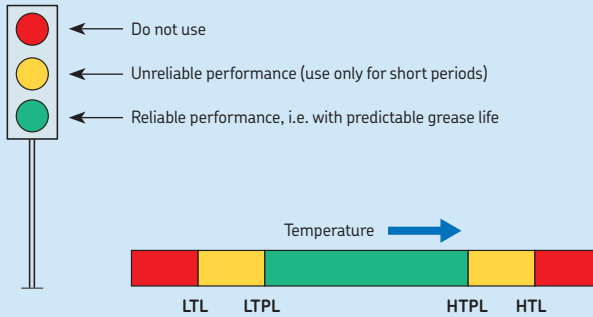

LTL – Low temperature limit

This limit indicates the lowest temperature at which the grease allows the bearing to be started up without difficulty.

LTPL – Low temperature performance limit

Below this limit, the supply of grease to the contact surfaces becomes insufficient.

HTPL – High temperature performance limit

Above this limit, the grease ages and oxidize in an uncontrolled way, so that grease life cannot be determined accurately.

HTL – High temperature limit

When exceeding this limit, the grease loses its structure permanently.

The SKF traffic light concept – temperature limits for SKF greases when used in spherical plain bearings requiring maintenance

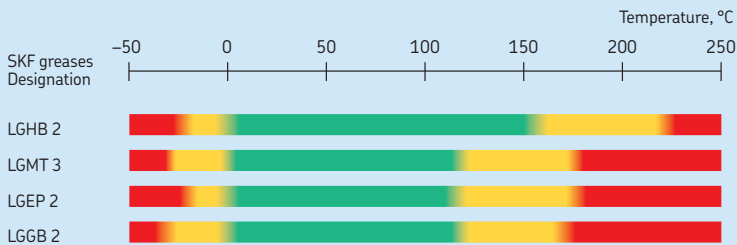

Fig. 1

Relubricating the bearing via the outer ring

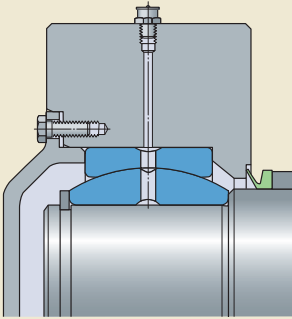

Fig. 2

Relubricating the bearing via the inner ring

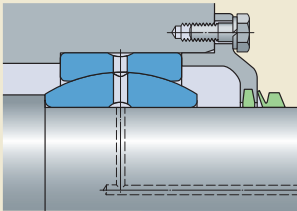
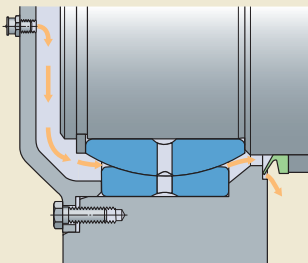

Fig. 3

Relubricating the bearing from the side



Spherical plain bearings requiring maintenance

Steel/steel radial spherical plain bearings must be relubricated to:

- reduce friction
- reduce wear
- extend bearing service life
- protect against corrosion and contaminants

The sliding contact surfaces are phosphated and treated with a “running-in” lubricant. This special surface treatment has a favourable influence during the running-in phase. The bearings must be greased prior to use and relubricated on a regular basis.

To reliably relubricate the bearings, grease ducts should be provided in the housing (→ fig. 1) or shaft (→ fig. 2) so that fresh grease can be supplied directly to the bearing. All SKF steel/steel radial spherical plain bearings (with the exception of the smallest E and ESA design bearings) have an annular groove and lubrication holes in both the inner and outer rings to facilitate lubricant distribution to the sliding surfaces of the bearing.

If the arrangement is appropriately designed, the bearing can also be supplied with grease from the side. To facilitate the passing of grease through the bearing, the grease should be prevented from exiting the bearing arrangement from the side it is supplied, e.g. by an end cover, and to provide an opening for the grease to exit on the opposite side, e.g. a V-ring seal that can open if there is pressure from the inside (→ fig. 3).

Generally, where possible, the free space surrounding the bearing should be filled with grease.

SKF recommends using SKF LGHB 2 grease to lubricate steel/steel spherical plain bearings. Its properties include:

- excellent performance under heavy loads
- very good rust inhibitor
- very good resistance to ageing
- good water resistance
- a wide operating temperature range.

If operating temperatures exceed the temperature range limits, special grease should be used (→ **table 1**).

For additional information, contact the SKF application engineering service.

Table 1

SKF grease recommendations

Property	SKF greases (designation)		LGEP 2 steel/PTFE FRP	LGGB 21) steel/PTFE FRP
	LGHB 2 for sliding contact surface combinations steel/steel	LGMT 3 steel/bronze		
Thickener	Calcium sulphonate complex soap	Lithium soap	Lithium soap	Lithium/calcium soap
Base oil	Mineral oil	Mineral oil	Mineral oil	Ester oil
Colour	Brown	Yellowish brown	Light brown	White
Temperature range²⁾, °C LTL to HTPL	-20 to +150	-30 to +120	-20 to +110	-40 to +120
Kinematic viscosity of base oil, mm²/s at +40 °C at +100 °C	400 to 450 26,5	120 to 130 12	200 16	110 13
Consistency (to NLGI Scale)	2	3	2	2

¹⁾ Grease biologically degradable, for use in applications where strict ecological demands must be met and where lubrication cannot be dispensed with.

²⁾ Refer to the SKF traffic light concept, starting on **page 84**.

Maintenance-free spherical plain bearings

Steel/PTFE sintered bronze and steel/PTFE fabric sliding contact surface combinations

During operation, PTFE is transferred from the dry sliding contact surface of the outer ring to the hard chromium plated steel surface of the inner ring. Any external lubricant on the sliding contact surfaces would disturb this self-lubrication and shorten bearing service life.

As a result, these bearings must not be lubricated and do not have any relubrication facility.

Steel/PTFE FRP sliding contact surface combination

Bearings with this sliding contact surface combination are also self-lubricating and can be operated grease-free.

However, initial lubrication followed by occasional relubrication of steel/PTFE FRP bearings can extend the service life of the bearing by a factor of two or more. The inner rings of radial bearings or shaft washers of angular contact and thrust bearings are coated with a lithium base grease before leaving the factory.

If operating conditions are such that protection against corrosion and enhanced sealing are required, the free space surrounding the bearing (→ **fig. 4**) can be filled with the same grease that was used to lubricate the bearing. The appropriate time to replenish or renew the grease in the bearing arrangement is determined by the operating conditions and the ageing of the grease.

Rust inhibiting, water-repellent lithium base greases with a consistency of 2 on the NGLI scale should be used. SKF recommends SKF LGEP 2 grease (→ **table 1 on page 87**). Greases containing molybdenum disulphide or other solid lubricants should never be used.

CAUTION: Depending on their design, SKF spherical plain bearings are either completely or partially coated with an oily preservative or filled with grease. Avoid skin contact as these substances may cause skin irritation or an allergic reaction.

Fig. 4

Relubricating the bearing from the side

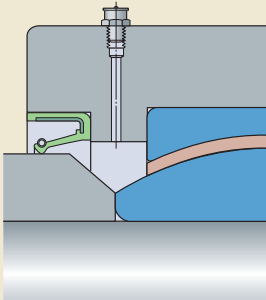

Rod ends requiring maintenance

Steel/steel and steel/bronze rod ends require lubrication. To facilitate this:

- All SKF steel/steel rod ends, with the exception of small-sized E and ESA design rod ends, can be relubricated via a lubrication hole or grease fitting in the rod end housing as well as via the pin and the inner ring (→ **fig. 5**).
- All SKF steel/bronze rod ends can be relubricated via a lubrication hole or grease fitting in the rod end housing (→ **fig. 6**).

The general recommendations for steel/steel radial spherical plain bearings also apply to steel/steel rod ends as well as steel/bronze rod ends.

For steel/bronze rod ends in the SIKAC .. M and SAKAC .. M series, SKF recommends SKF LGMT 3 grease (→ **table 1** on **page 87**). Lithium based greases with a normal consistency without solid lubricant additives can also be used.

Maintenance-free rod ends

Maintenance-free, self-lubricating rod ends are designed to be used as dry sliding bearings and must not be lubricated. Consequently, these rod ends do not have a relubrication facility in their housings.

Steel/PTFE FRP rod ends are an exception. They can be used without additional lubricant, but their service life can be extended appreciably if they are lubricated prior to use.

CAUTION: Depending on their design, SKF rod ends are either completely or partially coated with an oily preservative or filled with grease. Avoid skin contact as these substances may cause skin irritation or an allergic reaction.

Fig. 5

Relubrication facilities for steel/steel rod ends

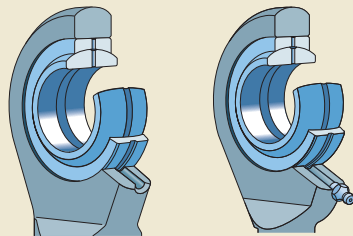

Lubrication hole

Grease fitting

Fig. 6

Relubrication facilities for steel/bronze rod ends (sizes 6 and larger)

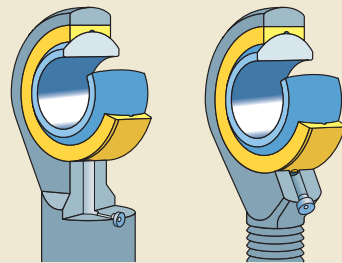

SIKAC .. M series

SAKAC .. M series

Relubrication

To maximize the service life of spherical plain bearings and rod ends requiring maintenance, they must be relubricated on a regular basis. This also applies to maintenance-free bearings with a steel/PTFE FRP sliding contact surface. Used grease containing wear debris and contaminants should be removed from the contact zone and replaced with fresh grease.

Determining the proper relubrication interval is extremely important because the attainable service life depends on several factors including:

- the magnitude of the load
- the type of load
- the angle of oscillation
- the frequency of oscillation
- the operating temperature
- the sealing arrangement
- other environmental conditions

Long bearing service life can be attained when the following basic relubrication rules are observed:

- the same type of grease is always used (→ **table 1** on **page 87**)
- the lubricant is applied at operating temperature
- the lubricant is applied before a long interruption, e.g. before construction or agricultural equipment is stored

Relubrication of non-locating bearings

Non-locating bearings, where axial displacement takes place along the shaft or pin, should always be relubricated via the shaft and bearing inner ring (→ **fig 2** on **page 86**). By supplying lubricant in this way, grease also enters between the mating surfaces of the inner ring and shaft seat. This reduces friction and induced axial loads when axial displacement occurs.

Storage

SKF spherical plain bearings and rod ends are treated with a preservative before they are packaged. They can, therefore, be stored in their original packages for several years. However, the relative humidity in the storeroom should not exceed 60%.

NOTE: SKF also supplies a comprehensive assortment of greases for various application requirements. For additional information, refer to the catalogue *SKF Maintenance and Lubrication Products* or online at www.mapro.skf.com.



SKF has the appropriate greases for spherical plain bearings and rod ends, including the biologically degradable SKF LGGB 2 grease

Mounting

Skill and cleanliness when mounting are necessary if spherical plain bearings and rod ends are to achieve maximum service life and not fail prematurely.

Bearings and rod ends should only be removed from their packages immediately prior to mounting so that they do not become contaminated. Bearing components that could have become dirty as a result of improper handling or damaged packaging should be wiped clean with a lint-free cloth.

The sliding contact surfaces of spherical plain bearings are matched to provide favourable friction and wear characteristics. Therefore, any alteration of the sliding surfaces can reduce bearing service life. Alterations in this context also include washing or exposing the sliding surfaces to solvents, cleaners, oils or similar media.

All associated components should be clean and free of any burrs. Also make sure to check each associated component for dimensional accuracy before the installation process is started.

Spherical plain bearings

When mounting spherical plain bearings with a fractured or split outer ring, it is essential that the joint is positioned at 90° to the direction of load (→ **fig. 1**), otherwise service life is reduced.

Steel or plastic bands that hold together spherical plain bearing outer rings must not be removed prior to mounting. They are positioned in an annular groove and do not protrude from the outside diameter surface.

Spherical plain bearing outer rings that are axially split and bolted together must be mounted as such, without loosening the bolts.

Mechanical mounting

The following tools are suitable for mounting spherical plain bearings:

- a mounting dolly (→ **fig. 2**) or length of tubing; the ring with an interference fit should generally be mounted first
- a dolly having two abutment surfaces (→ **fig. 3**) for simultaneously mounting the bearing on the shaft and in the housing
- for larger numbers of bearings, suitable tools can be used in combination with a press (→ **fig. 4**)

When mounting spherical plain bearings, consider the following:

- Never use a hammer or pin punch to drive a bearing in place, as either could damage the rings (→ **fig. 5**).
- The mounting force should never be directed through the sliding contact surfaces (→ **fig. 6**). This could damage the sliding contact surfaces and/or expand fractured or split bearing outer rings, which can cause an increase in the mounting force required.

Fig. 1

Plane of fracture or split and main direction of load

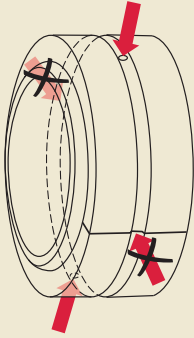

Fig. 2

Mounting with the aid of a dolly

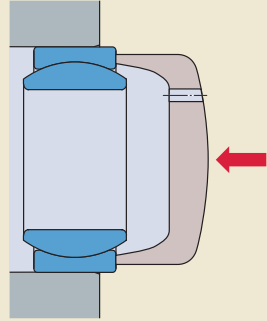

Fig. 3

Simultaneous mounting in the housing and on the shaft

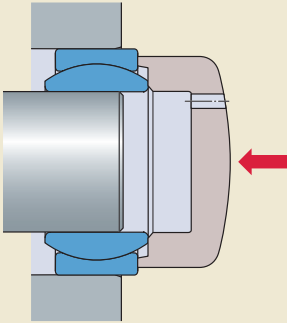

Fig. 4

Mounting using a press

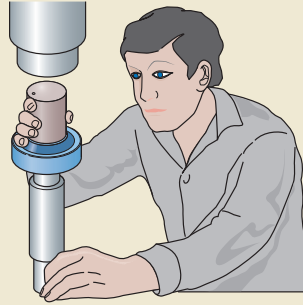

Fig. 5

Never hit the bearing rings directly

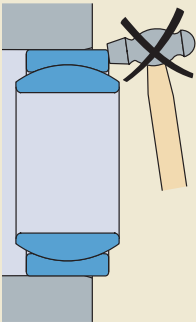
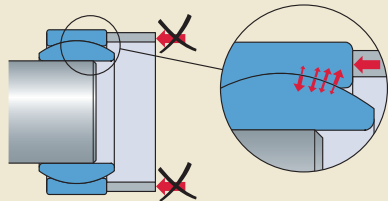

Fig. 6

Never apply the mounting force via the sliding contact surfaces



Mounting

Hot mounting

As a rule, larger bearings cannot be mounted cold because the force required to press a bearing into position increases considerably with its size. Therefore, SKF recommends the following:

- heat the bearing before it is mounted on the shaft (→ **fig. 7**)
- heat non-split housings before inserting the bearing

To mount a bearing on a shaft, a temperature differential of 60 to 80 °C between ambient temperature and the heated inner ring, is usually sufficient. For housings, the appropriate differential depends on the degree of interference and the seat diameter. However, a moderate

increase in temperature is usually sufficient. When heating the bearing, do not exceed the temperature limit of any associated components, such as the seals.

For an even and risk-free heat source, an induction heater should be used. The use of an SKF induction heater has a number of advantages. It heats the bearing rapidly and a built-in thermostat prevents overheating. The non-metallic components, such as the seals or PTFE fabric, remain cold as does the heater itself. SKF induction heaters automatically demagnetize the bearing after it has been heated.

Mounting bearings by cooling the shaft or the bearing is not recommended, as the very low temperatures required inevitably cause condensation, thus creating the risk of corrosion.

To ease the mounting of large bearings, particularly if they have been heated, it is possible to use slings and a hoist. Metal or textile slings placed around the outer ring can be used. A spring between the hoist hook and the sling also facilitates bearing handling (→ **fig. 8**).

Fig. 7

Mounting a heated bearing

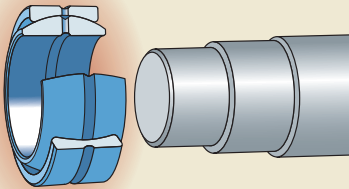
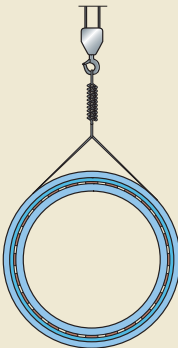

Fig. 8

Mounting a heated large bearing



WARNING!

Maintenance-free spherical plain bearings and rod ends must never be subjected to temperatures in excess of +280 °C due to the PTFE content. PTFE is completely inert below this temperature but at higher temperatures (from approx. 320 °C) it rapidly decomposes. The fluorine compounds released during this process are extremely toxic, even in small quantities, and can cause serious injury. It should also be remembered that the material is dangerous to handle once it has been overheated, even after it has cooled.

Heat-resistant gloves should be worn when handling hot components.

Rod ends

Rod ends are fitted on pins and shafts in the same way as spherical plain bearings. Slight heating reduces the force required for mounting and reduce the risk of damaging associated components.

When attaching rod ends to threaded rods or extension tubes (→ **fig. 9**) a counter lock nut should be used on the rod or on the external thread of the rod end. It should be securely tightened against the abutment surface on the rod end or tube.

NOTE: SKF supplies a comprehensive range of mechanical and hydraulic tools as well as heating equipment for bearing mounting and dismounting. For additional information, refer to the catalogue *SKF Maintenance and Lubrication Products* or online at www.mapro.skf.com.

Fig. 9

Securing a rod end with a right-hand thread

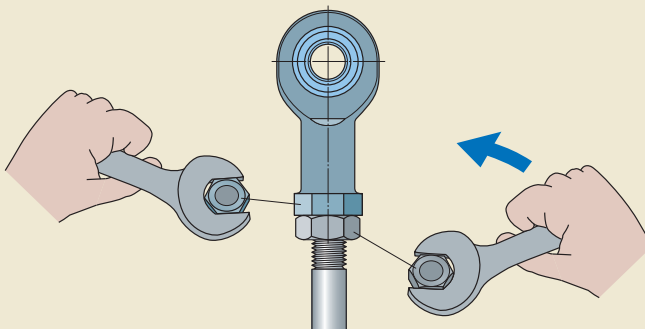

Dismounting

Spherical plain bearings

If bearings are to be re-used after dismounting, the same care and attention are required during dismounting as when mounting. The requisite withdrawal force should always be applied to the ring which is being dismounted.

SKF offers an assortment of different pullers to accommodate many applications. If the shaft is pre-machined to accommodate the arms of a jaw puller, then a two- or three-armed puller can be used (→ **fig. 1**).

In other cases where there is enough space behind the ring, a strong back puller such as the SKF TMBS series can be used (→ **fig. 2**).

For large bearings with an interference fit, dismounting is considerably facilitated if the SKF oil injection method is used (→ **fig. 3**). The oil ducts and distributor grooves should be provided when designing the bearing arrangement (→ **page 82**).

Small bearings can be dismounted using a mounting dolly or a length of tubing applied to the outer ring. For larger bearings with an interference fit, a mechanical or hydraulic press should be used when possible.

It is also possible to dismount a bearing from the housing bore by quickly heating the housing without heating the bearing outer ring to any extent.

Rod ends

To dismount rod ends, the lock nut securing the shank should be loosened and, if possible, the rod end should be unscrewed from its rod or tube. The rod end can then be removed from the pin or shaft in the same way as a bearing, e.g. using a puller or a press.

Fig. 1

Removing a bearing with a jaw puller

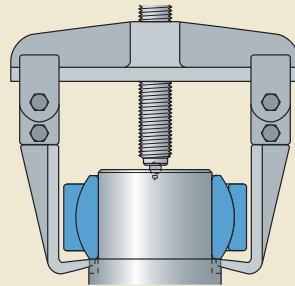

Fig. 2

A strong back puller facilitates dismounting of the inner ring

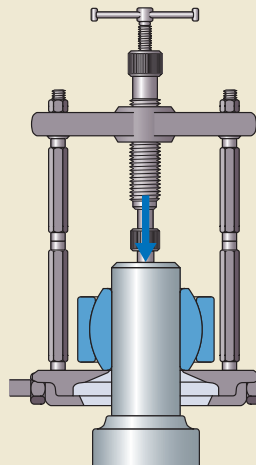
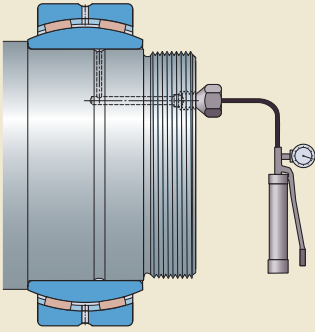

Fig. 3

Dismounting a bearing using the SKF oil injection method





Radial spherical plain bearings requiring maintenance

Dimensions	100
Tolerances	101
Radial internal clearance.....	102
Materials	102
Permissible operating temperature range	102
Product tables	104
2.1 Radial spherical plain bearings, steel/steel, metric sizes.....	104
2.2 Radial spherical plain bearings, steel/steel, inch sizes	110
2.3 Radial spherical plain bearings with an extended inner ring, steel/steel, metric sizes ..	116
2.4 Radial spherical plain bearings with an extended inner ring, steel/steel, inch sizes	120

Radial spherical plain bearings requiring maintenance

A characteristic feature of SKF steel/steel radial spherical plain bearings is the outer ring, which is intentionally fractured so that it can be sprung apart to enable the inner ring to be inserted (→ **fig. 1**). The bearings are therefore non-separable and easy to handle.

The bearings are manganese phosphated and the sliding contact surface is then treated with a running-in lubricant. This reduces friction and wear during the running-in period. To facilitate lubrication, all bearings, with the exception of some small sizes, have an annular groove and two lubrication holes in both the inner and outer rings. Metric bearings with an outside diameter $D \geq 150$ mm also have the SKF multi-groove system (→ **page 17**) in the outer ring sliding contact surface as standard (→ **fig. 2**). Upon request, SKF can also supply smaller metric and inch size bearings with the multi-groove system.

With the multi-groove system, SKF solved the problem of lubricant starvation in steel/steel bearings. Lubricant starvation is a common cause of premature bearing failure in applications where minor alignment movements are made under heavy, constant direction loads.

The multi-groove system improves lubricant distribution in the heavily loaded zone to extend bearing service life and/or maintenance intervals.

Dimensions

The dimensions of spherical plain bearings in the GE, GEH and GEG series are in accordance with ISO 12240-1:1998.

Bearings in the GEM series, which have an extended inner ring, have a non-standard inner ring width, but otherwise have the same dimensions as GE series bearings.

Inch spherical plain bearings in the GEZ series are in accordance with the American Standard ANSI/ABMA Std. 22.2-1988.

Fig. 1

The fractured outer ring enables the bearing to be assembled

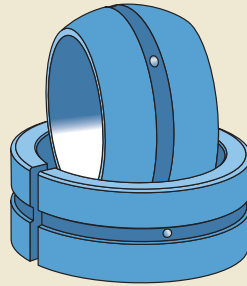

Fig. 2

Spherical plain bearing with the multi-groove system in the outer ring



Fig. 3

Spherical plain bearing with the multi-groove system, fitted with LS heavy-duty seals

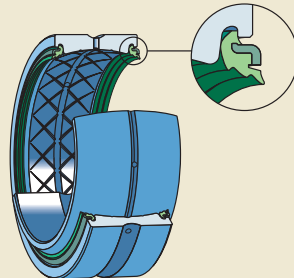

Tolerances

The dimensional tolerances for metric radial spherical plain bearings requiring maintenance in the GE, GEG, GEH and GEM series are listed in **table 1**. The dimensional tolerances for inch radial spherical plain bearings in the GEZ, GEZH and GEZM series are listed in **table 2** on **page 103**. Outer ring tolerances apply to conditions before fracture and surface treatment. Accordingly, inner ring tolerances apply to rings before surface treatment.

The tolerances are in accordance with ISO 12240-1:1998 (metric bearings) and ANSI/ABMA Std. 22.2-1988 (inch bearings).

The symbols used in the tolerance tables are explained in the following:

- d nominal bore diameter
- Δ_{dmp} deviation of the mean bore diameter from the nominal
- D nominal outside diameter
- Δ_{Dmp} deviation of the mean outside diameter from the nominal
- Δ_{Bs} deviation of the single inner ring width from the nominal
- Δ_{Cs} deviation of the single outer ring width from the nominal

Table 1

Dimensional tolerances for metric radial spherical plain bearings requiring maintenance

Nominal diameter		GE, GEH and GEM series				GEG series				All series			
d, D over		Inner ring		Inner ring		Inner ring		Inner ring		Outer ring		Outer ring	
incl.		Δ_{dmp} high	low	Δ_{Bs} high	low	Δ_{dmp} high	low	Δ_{Bs} high	low	Δ_{dmp} high	low	Δ_{Cs} high	low
mm		μm		μm		μm		μm		μm		μm	
–	6	0	–8	0	–120	–	–	–	–	–	–	–	–
6	10	0	–8	0	–120	–	–	–	–	0	–8	0	–240
10	18	0	–8	0	–120	+18	0	0	–180	0	–8	0	–240
18	30	0	–10	0	–120	+21	0	0	–210	0	–9	0	–240
30	50	0	–12	0	–120	+25	0	0	–250	0	–11	0	–240
50	80	0	–15	0	–150	+30	0	0	–300	0	–13	0	–300
80	120	0	–20	0	–200	+35	0	0	–350	0	–15	0	–400
120	150	0	–25	0	–250	+40	0	0	–400	0	–18	0	–500
150	180	0	–25	0	–250	+40	0	0	–400	0	–25	0	–500
180	250	0	–30	0	–300	+46	0	0	–460	0	–30	0	–600
250	315	0	–35	0	–350	–	–	–	–	0	–35	0	–700
315	400	–	–	–	–	–	–	–	–	0	–40	0	–800
400	500	–	–	–	–	–	–	–	–	0	–45	0	–900

Radial spherical plain bearings requiring maintenance

Radial internal clearance

Steel/steel radial spherical plain bearings are produced with Normal radial internal clearance as standard. The actual values are listed in **tables 3 and 4**. Prior to ordering, check availability of bearings with a smaller (C2) or larger (C3) radial internal clearance than Normal.

The clearance values for metric bearings are in accordance with ISO 12240-1:1998.

Materials

The inner and outer rings of SKF steel/steel radial spherical plain bearings are made of bearing steel. They are through-hardened, ground and phosphated. The sliding contact surfaces are treated with a running-in lubricant.

Depending on the bore diameter, metric bearings with a 2RS suffix have a double-lip seal made of a polyester elastomer or acrylonitrile-butadiene rubber on both sides of the bearing (→ **table 6 on page 79**). Inch bearings with a 2RS suffix have a double-lip seal made of polyurethane on both sides of the bearing.

Metric and inch bearings with the designation suffix -2LS have a sheet steel reinforced, triple-lip heavy-duty seal made of acrylonitrile-butadiene on both sides of the bearing.

Permissible operating temperature range

Open steel/steel radial spherical plain bearings have a permissible operating temperature range of -50 to $+200$ °C, but their load carrying capacity is reduced at temperatures above $+120$ °C. Bearings for higher temperature applications up to 300 °C, can be produced on request.

For sealed bearings, the permissible operating temperature range is limited by the seal material:

- -20 to $+80$ °C for inch RS seals
- -30 to $+130$ °C for metric RS seals with a bore diameter $d < 320$ mm
- -35 to $+100$ °C for metric RS seals with a bore diameter $d \geq 320$ mm
- -55 to $+110$ °C for LS seals

The operating temperature range of the grease used to lubricate the bearings must also be taken into consideration.

Table 2

Dimensional tolerances for inch bearings

Nominal diameter		GEZ, GEZH and GEZM series				Outer ring		Δ_{Cs}	
d, D over	incl.	Inner ring		Δ_{Bs}		Δ_{Dmp}		high low	
		Δ_{imp} high	low	high	low	high	low	high	low
in		μm							
–	2	0	–13	0	–130	0	–13	0	–130
2	3	0	–15	0	–130	0	–15	0	–130
3	3.1875	0	–20	0	–130	0	–15	0	–130
3.1875	4.75	0	–20	0	–130	0	–20	0	–130
4.75	6	0	–25	0	–130	0	–25	0	–130
6	7	–	–	–	–	0	–25	0	–130
7	8.75	–	–	–	–	0	–30	0	–130

Table 3

Radial internal clearance for steel/steel radial spherical plain bearings, metric sizes

Bore diameter		Radial internal clearance				C3	
d over	incl.	C2		Normal		min	max
		min	max	min	max	min	max
mm		μm					
–	12	8	32	32	68	68	104
12	20	10	40	40	82	82	124
20	35	12	50	50	100	100	150
35	60	15	60	60	120	120	180
60	90	18	72	72	142	142	212
90	140	18	85	85	165	165	245
140	200	18	100	100	192	192	284
200	240	18	110	110	214	214	318
240	300	18	125	125	239	239	353

Bearings in the GEH series, with a bore diameter $d = 20, 35, 60$ and 90 mm, have a radial internal clearance range corresponding to the next larger diameter range.

Table 4

Radial internal clearance for steel/steel radial spherical plain bearings, inch sizes

Bore diameter		Radial internal clearance				C3	
d over	incl.	C2		Normal		min	max
		min	max	min	max	min	max
in		μm					
–	0.625	15	75	50	150	150	200
0.625	2	25	105	80	180	180	260
2	3	30	130	100	200	200	300
3	6	40	160	130	230	230	350

Radial spherical plain bearings, steel/steel, metric sizes

d 4 – 40 mm

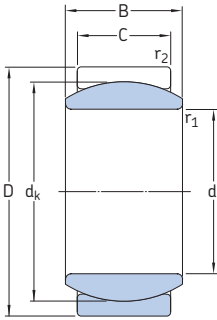

GE.. E

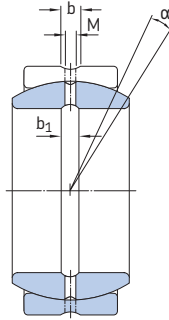

GE.. ES

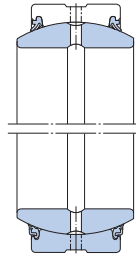

GE.. ES-2RS
GE.. ES-2LS

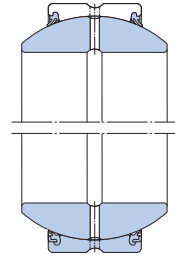

GEH.. ES-2RS
GEH.. ES-2LS

Principal dimensions				Angle of tilt ¹⁾ α	Basic load ratings		Mass	Designations ²⁾	
d	D	B	C		dynamic C	static C_0		without seals	with standards seals
mm				degrees	kN		kg	-	
4	12	5	3	16	2,04	10,2	0,003	GE 4 E	-
5	14	6	4	13	3,4	17	0,004	GE 5 E	-
6	14	6	4	13	3,4	17	0,004	GE 6 E	-
8	16	8	5	15	5,5	27,5	0,008	GE 8 E	-
10	19	9	6	12	8,15	40,5	0,012	GE 10 E	-
12	22	10	7	10	10,8	54	0,017	GE 12 E	-
15	26	12	9	8	17	85	0,032	GE 15 ES	-
	26	12	9	8	17	85	0,032	GE 15 ES-2RS	-
17	30	14	10	10	21,2	106	0,050	GE 17 ES	-
	30	14	10	10	21,2	106	0,050	GE 17 ES-2RS	-
20	35	16	12	9	30	146	0,065	GE 20 ES	-
	35	16	12	9	30	146	0,065	GE 20 ES-2RS	-2LS
	42	25	16	17	48	240	0,16	GEH 20 ES-2RS	-2LS
25	42	20	16	7	48	240	0,12	GE 25 ES	-
	42	20	16	7	48	240	0,12	GE 25 ES-2RS	-2LS
	47	28	18	17	62	310	0,20	GEH 25 ES-2RS	-2LS
30	47	22	18	6	62	310	0,16	GE 30 ES	-
	47	22	18	6	62	310	0,16	GE 30 ES-2RS	-2LS
	55	32	20	17	80	400	0,35	GEH 30 ES-2RS	-2LS
35	55	25	20	6	80	400	0,23	GE 35 ES	-
	55	25	20	6	80	400	0,23	GE 35 ES-2RS	-2LS
	62	35	22	15	100	500	0,47	GEH 35 ES-2RS	-2LS
40	62	28	22	7	100	500	0,32	GE 40 ES	-
	62	28	22	6	100	500	0,32	GE 40 ES-2RS	-2LS
	68	40	25	17	127	640	0,61	GEH 40 ES-2RS	-2LS

¹⁾ To fully utilize the angle of tilt, the shaft shoulder should not be made larger than $d_{a \max}$.

²⁾ Bearings with an outside diameter $D \geq 150$ mm have the multi-groove system in the outer ring as standard. Bearings with an outside diameter $D < 150$ mm can be supplied with the multi-groove system on request (designation suffix ESL).

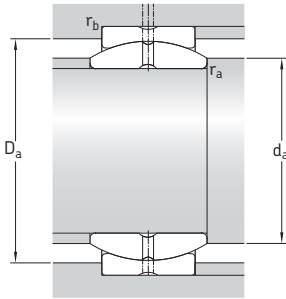

Dimensions

Abutment and fillet dimensions

d	d _k	b	b ₁	M	r ₁ min	r ₂ min	d _a min	d _a max	D _a min	D _a max	r _a max	r _b max
mm							mm					
4	8	–	–	–	0,3	0,3	5,5	6,2	7,6	10,7	0,3	0,3
5	10	–	–	–	0,3	0,3	6,6	8	9,5	12,6	0,3	0,3
6	10	–	–	–	0,3	0,3	7,5	8	9,5	12,6	0,3	0,3
8	13	–	–	–	0,3	0,3	9,6	10,2	12,3	14,5	0,3	0,3
10	16	–	–	–	0,3	0,3	11,7	13,2	17,5	15,2	0,3	0,3
12	18	–	–	–	0,3	0,3	13,8	15	17,1	20,4	0,3	0,3
15	22	2,3	2,3	1,5	0,3	0,3	16,9	18,4	20,9	24,3	0,3	0,3
	22	2,3	2,3	1,5	0,3	0,3	16,9	18,4	22,8	24,3	0,3	0,3
17	25	2,3	2,3	1,5	0,3	0,3	19	20,7	23,7	28,3	0,3	0,3
	25	2,3	2,3	1,5	0,3	0,3	19	20,7	26	28,3	0,3	0,3
20	29	3,1	3,1	2	0,3	0,3	22,1	24,2	27,6	33,2	0,3	0,3
	29	3,1	3,1	2	0,3	0,3	22,1	24,2	30,9	33,2	0,3	0,3
	35,5	3,1	3,1	2	0,3	0,6	22,7	25,2	36,9	39,2	0,3	0,6
25	35,5	3,1	3,1	2	0,6	0,6	28,2	29,3	33,7	39,2	0,6	0,6
	35,5	3,1	3,1	2	0,6	0,6	28,2	29,3	36,9	39,2	0,6	0,6
	40,7	3,1	3,1	2	0,6	0,6	28,6	29,5	41,3	44	0,6	0,6
30	40,7	3,1	3,1	2	0,6	0,6	33,3	34,2	38,7	44	0,6	0,6
	40,7	3,1	3,1	2	0,6	0,6	33,3	34,2	41,3	44	0,6	0,6
	47	3,9	3,9	2,5	0,6	1	33,7	34,4	48,5	50,9	0,6	1
35	47	3,9	3,9	2,5	0,6	1	38,5	39,8	44,6	50,9	0,6	1
	47	3,9	3,9	2,5	0,6	1	38,5	39,8	48,5	50,9	0,6	1
	53	3,9	3,9	2,5	0,6	1	38,8	39,8	54,5	57,8	0,6	1
40	53	3,9	3,9	2,5	0,6	1	43,6	45	50,3	57,8	0,6	1
	53	3,9	3,9	2,5	0,6	1	43,6	45	54,5	57,8	0,6	1
	60	4,6	4,6	3	0,6	1	44,1	44,7	61	63,6	0,6	1

Radial spherical plain bearings, steel/steel, metric sizes
d 45 – 120 mm

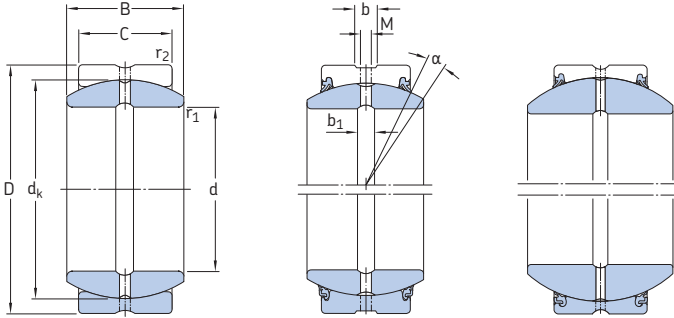

GE .. ES

GE .. ES-2RS
 GE .. ES-2LS

GEH .. ES-2RS
 GEH .. ES-2LS

Principal dimensions				Angle of tilt ¹⁾	Basic load ratings		Mass	Designations ²⁾	suffix for heavy-duty seals
d	D	B	C	α	C	C ₀		without seals	with standard seals
mm				degrees	kN		kg	-	
45	68	32	25	7	127	640	0,46	GE 45 ES	-
	68	32	25	7	127	640	0,46	GE 45 ES-2RS	-2LS
	75	43	28	14	156	780	0,80	GEH 45 ES-2RS	-2LS
50	75	35	28	6	156	780	0,56	GE 50 ES	-
	75	35	28	6	156	780	0,56	GE 50 ES-2RS	-2LS
	90	56	36	17	245	1 220	1,60	GEH 50 ES-2RS	-2LS
60	90	44	36	6	245	1 220	1,10	GE 60 ES	-
	90	44	36	6	245	1 220	1,10	GE 60 ES-2RS	-2LS
	105	63	40	17	315	1 560	2,40	GEH 60 ES-2RS	-2LS
70	105	49	40	6	315	1 560	1,55	GE 70 ES	-
	105	49	40	6	315	1 560	1,55	GE 70 ES-2RS	-2LS
	120	70	45	16	400	2 000	3,40	GEH 70 ES-2RS	-2LS
80	120	55	45	6	400	2 000	2,30	GE 80 ES	-
	120	55	45	5	400	2 000	2,30	GE 80 ES-2RS	-2LS
	130	75	50	14	490	2 450	4,10	GEH 80 ES-2RS	-2LS
90	130	60	50	5	490	2 450	2,75	GE 90 ES	-
	130	60	50	5	490	2 450	2,75	GE 90 ES-2RS	-2LS
	150	85	55	15	610	3 050	6,30	GEH 90 ES-2RS	-2LS
100	150	70	55	7	610	3 050	4,40	GE 100 ES	-
	150	70	55	6	610	3 050	4,40	GE 100 ES-2RS	-2LS
	160	85	55	13	655	3 250	6,80	GEH 100 ES-2RS	-2LS
110	160	70	55	6	655	3 250	4,80	GE 110 ES	-
	160	70	55	6	655	3 250	4,80	GE 110 ES-2RS	-2LS
	180	100	70	12	950	4 750	11,0	GEH 110 ES-2RS	-2LS
120	180	85	70	6	950	4 750	8,25	GE 120 ES	-
	180	85	70	6	950	4 750	8,25	GE 120 ES-2RS	-2LS
	210	115	70	16	1 080	5 400	15,0	GEH 120 ES-2RS	-2LS

¹⁾ To fully utilize the angle of tilt, the shaft shoulder should not be made larger than $d_{a \max}$.

²⁾ Bearings with an outside diameter $D \geq 150$ mm have the multi-groove system in the outer ring as standard. Bearings with an outside diameter $D < 150$ mm can be supplied with the multi-groove system on request (designation suffix ESL).

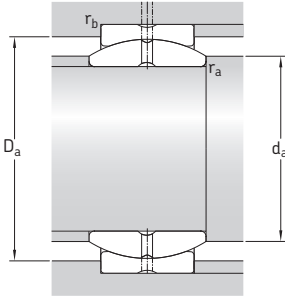

Dimensions

Abutment and fillet dimensions

d	d _k	b	b ₁	M	r ₁ min	r ₂ min	d _a min	d _a max	D _a min	D _a max	r _a max	r _b max
mm							mm					
45	60	4,6	4,6	3	0,6	1	49,4	50,8	57	63,6	0,6	1
	60	4,6	4,6	3	0,6	1	49,4	50,8	61	63,6	0,6	1
	66	4,6	4,6	3	0,6	1	49,8	50,1	66,2	70,5	0,6	1
50	66	4,6	4,6	3	0,6	1	54,6	56	62,7	70,5	0,6	1
	66	4,6	4,6	3	0,6	1	54,6	56	66,2	70,5	0,6	1
	80	6,2	6,2	4	0,6	1	55,8	57,1	79,7	84,2	0,6	1
60	80	6,2	6,2	4	1	1	66,4	66,8	76	84,2	1	1
	80	6,2	6,2	4	1	1	66,4	66,8	79,7	84,2	1	1
	92	7,7	7,7	4	1	1	67	67	92	99	1	1
70	92	7,7	7,7	4	1	1	76,7	77,9	87,4	99	1	1
	92	7,7	7,7	4	1	1	76,7	77,9	92	99	1	1
	105	7,7	7,7	4	1	1	77,5	78,3	104,4	113,8	1	1
80	105	7,7	7,7	4	1	1	87,1	89,4	99,7	113,8	1	1
	105	7,7	7,7	4	1	1	87,1	89,4	104,4	113,8	1	1
	115	9,5	9,5	5	1	1	87,2	87,2	112,9	123,5	1	1
90	115	9,5	9,5	5	1	1	97,4	98,1	109,3	123,5	1	1
	115	9,5	9,5	5	1	1	97,4	98,1	112,9	123,5	1	1
	130	11,3	11,3	5	1	1	98,2	98,4	131	143,2	1	1
100	130	11,3	11,3	5	1	1	107,8	109,5	123,5	143,2	1	1
	130	11,3	11,3	5	1	1	107,8	109,5	131	143,2	1	1
	140	11,5	11,5	5	1	1	108,1	111,2	141,5	153,3	1	1
110	140	11,5	11,5	5	1	1	118	121	133	153	1	1
	140	11,5	11,5	5	1	1	118	121	141,5	153	1	1
	160	13,5	13,5	6	1	1	119,5	124,5	157,5	172	1	1
120	160	13,5	13,5	6	1	1	129,5	135,5	152	172	1	1
	160	13,5	13,5	6	1	1	129,5	135,5	157,5	172	1	1
	180	13,5	13,5	6	1	1	130	138,5	180	202,5	1	1

Radial spherical plain bearings, steel/steel, metric sizes
d 140 – 300 mm

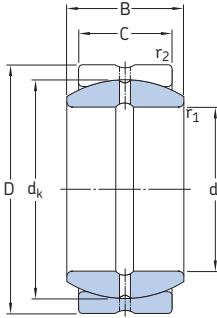

GE .. ES

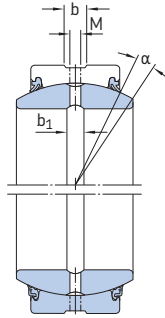

GE .. ES-2RS
GE .. ES-2LS

Principal dimensions				Angle of tilt ¹⁾	Basic load ratings		Mass	Designations ²⁾	suffix for heavy-duty seals
d	D	B	C	α	C	C ₀	without seals with standard seals		
mm				degrees	kN		kg	–	
140	210	90	70	7	1 080	5 400	11,0	GE 140 ES	–
	210	90	70	7	1 080	5 400	11,0	GE 140 ES-2RS	-2LS
160	230	105	80	8	1 370	6 800	14,0	GE 160 ES	–
	230	105	80	8	1 370	6 800	14,0	GE 160 ES-2RS	-2LS
180	260	105	80	6	1 530	7 650	18,5	GE 180 ES	–
	260	105	80	6	1 530	7 650	18,5	GE 180 ES-2RS	-2LS
200	290	130	100	7	2 120	10 600	28,0	GE 200 ES	–
	290	130	100	7	2 120	10 600	28,0	GE 200 ES-2RS	-2LS
220	320	135	100	8	2 320	11 600	35,5	GE 220 ES-2RS	-2LS
240	340	140	100	8	2 550	12 700	40,0	GE 240 ES-2RS	-2LS
260	370	150	110	7	3 050	15 300	51,5	GE 260 ES-2RS	-2LS
280	400	155	120	6	3 550	18 000	65,0	GE 280 ES-2RS	-2LS
300	430	165	120	7	3 800	19 000	78,5	GE 300 ES-2RS	-2LS

¹⁾ To fully utilize the angle of tilt, the shaft shoulder should not be made larger than $d_{a \max}$.

²⁾ Bearings with an outside diameter $D \geq 150$ mm have the multi-groove system in the outer ring as standard.

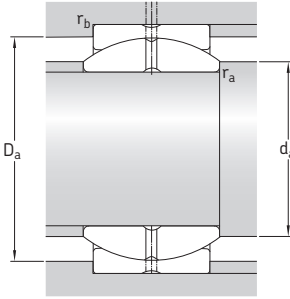

Dimensions

Abutment and fillet dimensions

d	d_k	b	b_1	M	r_1 min	r_2 min	d_a min	d_a max	D_a min	D_a max	r_a max	r_b max
mm							mm					
140	180	13,5	13,5	6	1	1	149	155,5	171	202,5	1	1
	180	13,5	13,5	6	1	1	149	155,5	180	202,5	1	1
160	200	13,5	13,5	6	1	1	169,5	170	190	222	1	1
	200	13,5	13,5	6	1	1	169,5	170	197	222	1	1
180	225	13,5	13,5	6	1,1	1,1	191	199	214	250,5	1	1
	225	13,5	13,5	6	1,1	1,1	191	199	224,5	250,5	1	1
200	250	15,5	15,5	7	1,1	1,1	212,5	213,5	237,5	279,5	1	1
	250	15,5	15,5	7	1,1	1,1	212,5	213,5	244,5	279,5	1	1
220	275	15,5	15,5	7	1,1	1,1	232,5	239,5	271	309,5	1	1
240	300	15,5	15,5	7	1,1	1,1	252,5	265	298	329,5	1	1
260	325	15,5	15,5	7	1,1	1,1	273	288	321,5	359	1	1
280	350	15,5	15,5	7	1,1	1,1	294	313,5	344,5	388,5	1	1
300	375	15,5	15,5	7	1,1	1,1	314	336,5	371	418,5	1	1

Radial spherical plain bearings, steel/steel, inch sizes
d 0.5 – 2 in

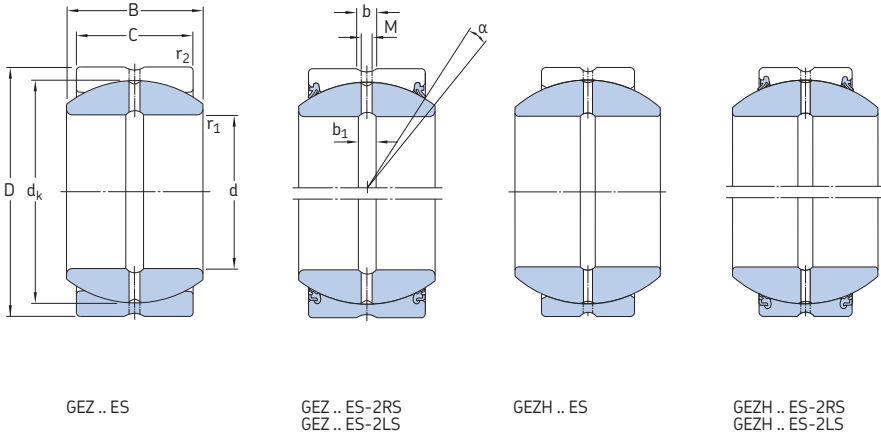

Principal dimensions				Angle of tilt ¹⁾	Basic load ratings		Mass	Designations		
d	D	B	C		dynamic	static		without seals	suffix for seal variants	
in/mm				degrees	lbf/kN		lb/kg	–	standard	heavy-duty
0.5 12,700	0.8750 22,225	0.437 11,10	0.375 9,53	6	3 150 14	9 340 41,5	0.044 0,020	GEZ 008 ES	–	–
0.625 15,875	1.0625 26,988	0.547 13,89	0.469 11,91	6	4 840 21,5	14 740 65,5	0.077 0,035	GEZ 010 ES	–	–
0.75 19,050	1.2500 31,750	0.656 16,66	0.562 14,28	6	7 090 31,5	20 930 93	0.12 0,055	GEZ 012 ES	-2RS	–
0.875 22,225	1.4375 36,513	0.765 19,43	0.656 16,66	6	9 560 42,5	28 580 127	0.19 0,085	GEZ 014 ES	–	–
1 25,400	1.6250 41,275	0.875 22,23	0.750 19,05	6	12 600 56	37 350 166	0.26 0,12	GEZ 100 ES	-2RS	-2LS
1.25 31,750	2.0000 50,800	1.093 27,76	0.937 23,80	6	19 460 86,5	58 500 260	0.51 0,23	GEZ 104 ES	-2RS	-2LS
	2.4375 61,913	1.390 35,31	1.125 28,58	8	28 125 125	84 375 375	1.20 0,54	GEZH 104 ES	-2RS	-2LS
1.375 34,925	2.1875 55,563	1.187 30,15	1.031 26,19	6	23 400 104	69 750 310	0.77 0,35	GEZ 106 ES	-2RS	-2LS
1.5 38,100	2.4375 61,913	1.312 33,33	1.125 28,58	6	28 130 125	84 380 375	0.93 0,42	GEZ 108 ES	-2RS	-2LS
	2.8125 71,438	1.580 40,13	1.312 33,33	7	38 250 170	114 750 510	1.75 0,79	GEZH 108 ES	-2RS	-2LS
1.75 44,450	2.8125 71,438	1.531 38,89	1.312 33,33	6	38 250 170	114 750 510	1.40 0,64	GEZ 112 ES	-2RS	-2LS
	3.1875 80,963	1.820 46,23	1.500 38,10	7	50 400 224	150 750 670	2.50 1,13	GEZH 112 ES	-2RS	-2LS
2 50,800	3.1875 80,963	1.750 44,45	1.500 38,10	6	50 400 224	150 750 670	2.05 0,93	GEZ 200 ES	-2RS	-2LS
	3.5625 90,488	2.070 52,58	1.687 42,85	8	63 000 280	191 250 850	3.50 1,60	GEZH 200 ES	-2RS	-2LS

¹⁾ To fully utilize the angle of tilt, the shaft shoulder should not be larger than $d_{a \max}$.

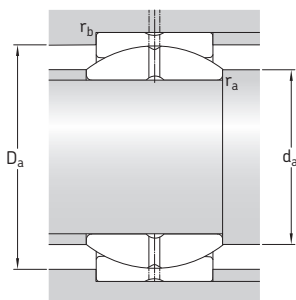

Dimensions

Abutment and fillet dimensions

d	d _k	b	b ₁	M	r ₁ ¹⁾ min	r ₂ ²⁾ min	d _a min	d _a max	D _a min	D _a sealed min	D _a max	r _a max	r _b max
in/mm							in/mm						
0.5 12,700	0.7190 18,263	0.102 2,6	0.098 2,5	0.059 1,5	0.006 0,2	0.024 0,6	0.54 13,7	0.57 14,5	0.68 17,3	–	0.78 19,9	0.006 0,2	0.024 0,6
0.625 15,875	0.8990 22,835	0.126 3,2	0.118 3	0.098 2,5	0.006 0,2	0.039 1	0.67 17	0.71 18,1	0.85 21,7	–	0.93 23,6	0.006 0,2	0.039 1
0.75 19,050	1.0800 27,432	0.126 3,2	0.118 3	0.098 2,5	0.012 0,3	0.039 1	0.82 20,9	0.86 21,8	1.03 26,1	1.1 27,9	1.11 28,3	0.012 0,3	0.039 1
0.875 22,225	1.2580 31,953	0.126 3,2	0.118 3	0.098 2,5	0.012 0,3	0.039 1	0.95 24,2	1 25,4	1.2 30,4	–	1.3 33	0.012 0,3	0.039 1
1 25,400	1.4370 36,500	0.126 3,2	0.118 3	0.098 2,5	0.012 0,3	0.039 1	1.08 27,5	1.14 29	1.37 34,7	1.39 35,2	1.48 37,7	0.012 0,3	0.039 1
1.25 31,750	1.7950 45,593	0.189 4,8	0.197 5	0.157 4	0.024 0,6	0.039 1	1.37 34,8	1.43 36,2	1.7 43,3	1.76 44,8	1.85 47	0.024 0,6	0.039 1
	2.1550 54,737	0.189 4,8	0.197 5	0.157 4	0.039 1	0.039 1	1.43 36,2	1.65 41,8	2.05 52	2.06 52,3	2.28 58	0.039 1	0.039 1
1.375 34,925	1.9370 49,200	0.189 4,8	0.197 5	0.157 4	0.024 0,6	0.039 1	1.5 38,1	1.53 38,9	1.84 46,7	1.85 47,1	2.035 51,7	0.024 0,6	0.039 1
1.5 38,100	2.1550 54,737	0.189 4,8	0.197 5	0.157 4	0.024 0,6	0.039 1	1.63 41,4	1.71 43,4	2.05 52	2.06 52,3	2.28 58	0.024 0,6	0.039 1
	2.5150 63,881	0.189 4,8	0.197 5	0.157 4	0.039 1	0.039 1	1.69 42,8	1.96 49,7	2.39 60,7	2.41 61,3	2.65 67,4	0.039 1	0.039 1
1.75 44,450	2.5150 63,881	0.189 4,8	0.197 5	0.157 4	0.024 0,6	0.039 1	1.91 48,5	2 50,7	2.39 60,7	2.41 61,3	2.65 67,4	0.024 0,6	0.039 1
	2.8750 73,025	0.189 4,8	0.197 5	0.157 4	0.059 1,5	0.039 1	2.00 50,9	2.22 56,5	2.73 69,4	2.85 72,4	2.99 75,9	0.059 1,5	0.039 1
2 50,800	2.8750 73,025	0.189 4,8	0.197 5	0.157 4	0.024 0,6	0.039 1	2.17 55,1	2.28 57,9	2.73 69,4	2.85 72,4	2.99 75,9	0.024 0,6	0.039 1
	3.2350 82,169	0.224 5,7	0.197 5	0.157 4	0.059 1,5	0.039 1	2.26 57,5	2.48 63,1	3.07 78,1	3.11 79	3.36 85,3	0.059 1,5	0.039 1

¹⁾ Equal to maximum shaft fillet radius $r_{a \max}$.

²⁾ Equal to maximum housing fillet radius $r_{b \max}$.

Radial spherical plain bearings, steel/steel, inch sizes
d 2.25 – 4 in

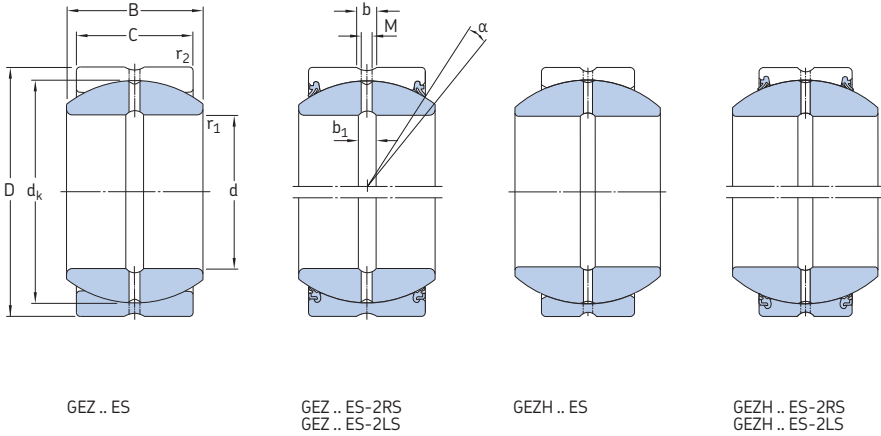

Principal dimensions				Angle of tilt ¹⁾	Basic load ratings		Mass	Designations	suffix for seal variants	
d	D	B	C	α	C	C ₀		without seals	standard	heavy-duty
in/mm				degrees	lbf/kN		lb/kg	-		
2.25 57,150	3.5625	1.969	1.687	6	63 000	191 250	2.85	GEZ 204 ES	-2RS	-2LS
	90,488	50,01	42,85	8	280	850	1,30	GEZH 204 ES	-2RS	-2LS
	3.9375	2.318	1.875		77 625	234 000	4.65			
	100,013	58,88	47,63		345	1 040	2,10			
2.5 63,500	3.9375	2.187	1.875	6	77 630	234 000	4.10	GEZ 208 ES	-2RS	-2LS
	100,013	55,55	47,63	8	345	1 040	1,85	GEZH 208 ES	-2RS	-2LS
	4.3750	2.545	2.062		95 625	285 750	6.30			
	111,125	64,64	52,38		425	1 270	2,85			
2.75 69,850	4.3750	2.406	2.062	6	95 630	285 750	5.30	GEZ 212 ES	-2RS	-2LS
	111,125	61,11	52,38	8	425	1 270	2,40	GEZH 212 ES	-2RS	-2LS
	4.7500	2.790	2.250		112 500	337 500	8.05			
	120,650	70,87	57,15		500	1 500	3,65			
3 76,200	4.7500	2.625	2.250	6	112 500	337 500	6.85	GEZ 300 ES	-2RS	-2LS
	120,650	66,68	57,15	8	500	1 500	3,10	GEZH 300 ES	-2RS	-2LS
	5.1250	3.022	2.437		131 625	396 000	10.0			
	130,175	76,76	61,90		585	1 760	4,55			
3.25 82,550	5.1250	2.844	2.437	6	131 630	396 000	8.40	GEZ 304 ES	-2RS	-2LS
	130,175	72,24	61,90	9	585	1 760	3,80	GEZH 304 ES	-2RS	-2LS
	5.5000	3.265	2.625		153 000	459 000	12.3			
	139,700	82,93	66,68		680	2 040	5,60			
3.5 88,900	5.5000	3.062	2.625	6	153 000	459 000	10.5	GEZ 308 ES	-2RS	-2LS
	139,700	77,78	66,68	9	680	2 040	4,80	GEZH 308 ES	-2RS	-2LS
	5.8750	3.560	2.812		175 500	531 000	15.0			
	149,225	90,42	71,43		780	2 360	6,80			
3.75 95,250	5.8750	3.281	2.812	6	175 500	531 000	13.0	GEZ 312 ES	-2RS	-2LS
	149,225	83,34	71,43	9	780	2 360	5,80	GEZH 312 ES	-2RS	-2LS
	6.2500	3.738	3.000		202 500	596 250	17.9			
	158,750	94,95	76,20		900	2 650	8,10			
4 101,600	6.2500	3.500	3.000	6	202 500	596 250	15.5	GEZ 400 ES	-2RS	-2LS
	158,750	88,90	76,20	9	900	2 650	7,00	GEZH 400 ES	-2RS	-2LS
	7.0000	4.225	3.375		252 000	765 000	30.0			
	177,800	107,32	85,73		1 120	3 400	13,5			

¹⁾ To fully utilize the angle of tilt, the shaft shoulder should not be larger than $d_{a\max}$.

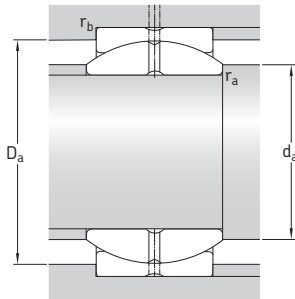

Dimensions

Abutment and fillet dimensions

d	d _k	b	b ₁	M	r ₁ ¹⁾ min	r ₂ ²⁾ min	d _a min	d _a max	D _a min	D _a sealed min	D _a max	r _a max	r _b max
in/mm							in/mm						
2.25 57,150	3.2350	0.224	0.197	0.157	0.024	0.039	2.43	2.57	3.07	3.11	3.36	0.024	0.039
	82,169	5,7	5	4	0,6	1	61,7	65,2	78,1	79	85,3	0,6	1
	3.5900	0.354	0.315	0.256	0.059	0.039	2.52	2.74	3.41	3.43	3.73	0.059	0.039
	91,186	9	8	6,5	1,5	1	64,1	69,6	86,6	87	94,7	1,5	1
2.5 63,500	3.5900	0.354	0.315	0.256	0.024	0.039	2.69	2.85	3.41	3.43	3.73	0.024	0.039
	91,186	9	8	6,5	0,6	1	68,3	72,3	86,6	87	94,7	0,6	1
	3.9500	0.354	0.315	0.256	0.079	0.039	2.84	3.02	3.75	3.78	4.16	0.079	0.039
	100,330	9	8	6,5	2	1	72	76,7	95,3	96	105,7	2	1
2.75 69,850	3.9500	0.354	0.315	0.256	0.024	0.039	2.95	3.13	3.75	3.78	4.16	0.024	0.039
	100,330	9	8	6,5	0,6	1	74,9	79,6	95,3	96	105,7	0,6	1
	4.3120	0.354	0.315	0.256	0.079	0.039	3.09	3.29	4.09	4.13	4.53	0.079	0.039
	109,525	9	8	6,5	2	1	78,6	83,5	104	104,8	115	2	1
3 76,200	4.3120	0.354	0.315	0.256	0.024	0.039	3.2	3.42	4.09	4.13	4.53	0.024	0.039
	109,525	9	8	6,5	0,6	1	81,4	86,9	104	104,8	115	0,6	1
	4.6750	0.366	0.315	0.256	0.079	0.039	3.35	3.57	4.44	4.5	4.90	0.079	0.039
	118,745	9,3	8	6,5	2	1	85,1	90,6	112,8	114,2	124,4	2	1
3.25 82,550	4.6750	0.366	0.315	0.256	0.024	0.039	3.46	3.71	4.44	4.5	4.9	0.024	0.039
	118,745	9,3	8	6,5	0,6	1	88	94,2	112,8	114,2	124,4	0,6	1
	5.0400	0.413	0.315	0.256	0.079	0.039	3.65	3.84	4.79	4.83	5.27	0.079	0.039
	128,016	10,5	8	6,5	2	1	92,7	97,5	121,6	122,8	133,8	2	1
3.5 88,900	5.0400	0.413	0.315	0.256	0.024	0.039	3.72	4	4.79	4.83	5.27	0.024	0.039
	128,016	10,5	8	6,5	0,6	1	94,6	101,7	121,6	122,8	133,8	0,6	1
	5.3900	0.413	0.315	0.256	0.079	0.039	3.91	4.04	5.12	5.17	5.63	0.079	0.039
	136,906	10,5	8	6,5	2	1	99,3	102,5	130,1	131,4	143,1	2	1
3.75 95,250	5.3900	0.413	0.315	0.256	0.024	0.039	3.98	4.28	5.12	5.17	5.63	0.024	0.039
	136,906	10,5	8	6,5	0,6	1	101,2	108,6	130,1	131,4	143,1	0,6	1
	5.7500	0.433	0.394	0.315	0.079	0.039	4.17	4.37	5.47	5.49	6.00	0.079	0.039
	146,050	10,5	10	8	2	1	105,8	110,9	139	139,5	152,5	2	1
4 101,600	5.7500	0.413	0.394	0.315	0.024	0.039	4.25	4.55	5.47	5.49	6	0.024	0.039
	146,050	10,5	10	8	0,6	1	108	115,5	139	139,5	152,5	0,6	1
	6.4750	0.433	0.394	0.315	0.079	0.043	4.45	4.9	6.16	6.18	6.73	0.079	0.043
	164,465	11	10	8	2	1,1	113	124,5	156,5	157	171	2	1,1

1) Equal to maximum shaft fillet radius r_a max.2) Equal to maximum housing fillet radius r_b max.

Radial spherical plain bearings, steel/steel, inch sizes
d 4.5 – 6 in

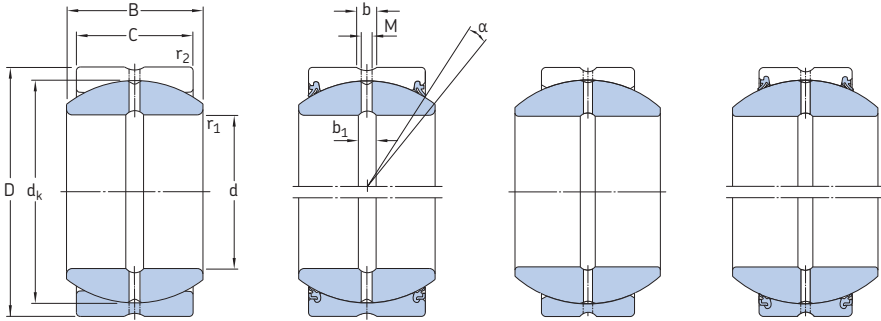

GEZ .. ES

GEZ .. ES-2RS
 GEZ .. ES-2LS

GEZH .. ES

GEZH .. ES-2RS
 GEZH .. ES-2LS

Principal dimensions				Angle of tilt ¹⁾	Basic load ratings		Mass	Designations		
d	D	B	C		dynamic	static		without seals	suffix for seal variants	
				α	C	C ₀		standard	heavy-duty	
in/mm				degrees	lbf/kN		lb/kg	–		
4.5 114,300	7.0000	3.937	3.375	6	252 000	765 000	21.5	GEZ 408 ES	-2RS	-2LS
	177,800	100,00	85,73		1 120	3 400	9,80			
	7.7500	4.690	3.750	9	315 000	933 750	36.0	GEZH 408 ES	-2RS	-2LS
	196,850	119,17	95,25		1 400	4 150	16,5			
4.75 120,650	7.3750	4.156	3.562	6	281 250	843 750	25.5	GEZ 412 ES	-2RS	-2LS
	187,325	105,56	90,48		1 250	3 750	11,5			
5 127,000	7.7500	4.375	3.750	6	315 000	933 750	30.0	GEZ 500 ES	-2RS	-2LS
	196,850	111,13	95,25		1 400	4 150	13,5			
5.5 139,700	8.7500	4.950	4.125	7	389 250	1 170 000	45.5	GEZH 508 ES	-2RS	-2LS
	222,250	125,73	104,78		1 730	5 200	20,5			
6 152,400	8.7500	4.750	4.125	5	389 250	1 170 000	38.5	GEZ 600 ES	-2RS	-2LS
	222,250	120,65	104,78		1 730	5 200	17,5			

¹⁾ To fully utilize the angle of tilt, the shaft shoulder should not be larger than $d_{a \max}$.

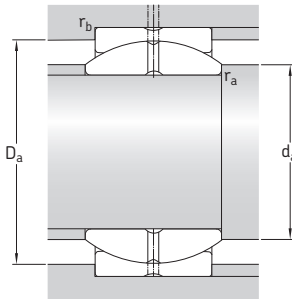

Dimensions

Abutment and fillet dimensions

d	d _k	b	b ₁	M	r ₁ ¹⁾ min	r ₂ ²⁾ min	d _a min	d _a max	D _a min	D _a sealed min	D _a max	r _a max	r _b max
in/mm							in/mm						
4.5	6.4750	0.433	0.394	0.315	0.039	0.043	4.82	5.14	6.16	6.18	6.73	0.039	0.043
<i>114,300</i>	<i>164,465</i>	<i>11</i>	<i>10</i>	<i>8</i>	<i>1</i>	<i>1,1</i>	<i>122,5</i>	<i>130,5</i>	<i>156,5</i>	<i>157</i>	<i>171</i>	<i>1</i>	<i>1,1</i>
	7.1900	0.433	0.394	0.315	0.079	0.043	4.96	5.45	6.83	6.91	7.42	0.079	0.043
	<i>182,626</i>	<i>11</i>	<i>10</i>	<i>8</i>	<i>2</i>	<i>1,1</i>	<i>126</i>	<i>138,4</i>	<i>173,5</i>	<i>175,5</i>	<i>188,5</i>	<i>2</i>	<i>1,1</i>
4.75	6.8250	0.433	0.394	0.315	0.039	0.043	5.08	5.41	6.5	6.56	7.05	0.039	0.043
<i>120,650</i>	<i>173,355</i>	<i>11</i>	<i>10</i>	<i>8</i>	<i>1</i>	<i>1,1</i>	<i>129</i>	<i>137,5</i>	<i>165</i>	<i>166,5</i>	<i>179</i>	<i>1</i>	<i>1,1</i>
5	7.1900	0.433	0.394	0.315	0.039	0.043	5.33	5.69	6.83	6.91	7.42	0.039	0.043
<i>127,000</i>	<i>182,626</i>	<i>11</i>	<i>10</i>	<i>8</i>	<i>1</i>	<i>1,1</i>	<i>135,5</i>	<i>144,5</i>	<i>173,5</i>	<i>175,5</i>	<i>188,5</i>	<i>1</i>	<i>1,1</i>
5.5	8.1560	0.591	0.433	0.315	0.079	0.043	5.98	6.46	7.76	7.78	8.41	0.079	0.043
<i>139,700</i>	<i>207,162</i>	<i>15</i>	<i>11</i>	<i>8</i>	<i>2</i>	<i>1,1</i>	<i>152</i>	<i>164</i>	<i>197</i>	<i>197,5</i>	<i>213,5</i>	<i>2</i>	<i>1,1</i>
6	8.1560	0.591	0.433	0.315	0.039	0.043	6.34	6.61	7.76	7.78	8.41	0.039	0.043
<i>152,400</i>	<i>207,162</i>	<i>15</i>	<i>11</i>	<i>8</i>	<i>1</i>	<i>1,1</i>	<i>161</i>	<i>168</i>	<i>197</i>	<i>197,5</i>	<i>213,5</i>	<i>1</i>	<i>1,1</i>

¹⁾ Equal to maximum shaft fillet radius $r_{a \max}$.

²⁾ Equal to maximum housing fillet radius $r_{b \max}$.

**Radial spherical plain bearings with an extended inner ring, steel/steel, metric sizes
d 12 – 125 mm**

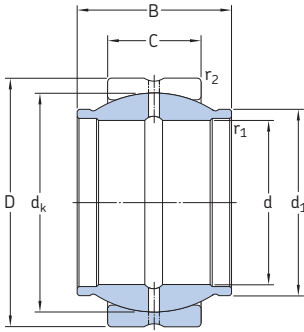

GEG .. ES

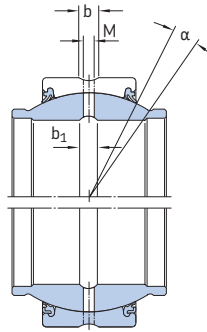

GEM .. ES-2RS
GEM .. ES-2LS

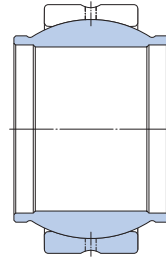

GEG .. ESA

Principal dimensions				Angle of tilt	Basic load ratings		Mass	Designations ¹⁾	
d	D	B	C	α	C	C ₀		without seals	suffix for heavy-duty seals
mm				degrees	kN		kg	-	
12	22	12	7	4	10,8	54	0,020	GEG 12 ESA ²⁾	-
16	28	16	9	4	17,6	88	0,035	GEG 16 ES	-
20	35	20	12	4	30	146	0,070	GEG 20 ES	-
	35	24	12	6	30	146	0,073	GEM 20 ES-2RS	-2LS
25	42	25	16	4	48	240	0,13	GEG 25 ES	-
	42	29	16	4	48	240	0,13	GEM 25 ES-2RS	-2LS
30	47	30	18	4	62	310	0,17	GEM 30 ES-2RS	-2LS
32	52	32	18	4	65,5	325	0,17	GEG 32 ES	-
35	55	35	20	4	80	400	0,25	GEM 35 ES-2RS	-2LS
40	62	38	22	4	100	500	0,35	GEM 40 ES-2RS	-2LS
	62	40	22	4	100	500	0,34	GEG 40 ES	-
45	68	40	25	4	127	640	0,49	GEM 45 ES-2RS	-2LS
50	75	43	28	4	156	780	0,60	GEM 50 ES-2RS	-2LS
	75	50	28	4	156	780	0,56	GEG 50 ES	-
60	90	54	36	3	245	1 220	1,15	GEM 60 ES-2RS	-2LS
63	95	63	36	4	255	1 270	1,25	GEG 63 ES	-
70	105	65	40	4	315	1 560	1,65	GEM 70 ES-2RS	-2LS
80	120	74	45	4	400	2 000	2,50	GEM 80 ES-2RS	-2LS
	120	80	45	4	400	2 000	2,40	GEG 80 ES	-
100	150	100	55	4	610	3 050	4,80	GEG 100 ES	-
125	180	125	70	4	950	4 750	8,50	GEG 125 ES	-

¹⁾ Bearings with an outside diameter $D \geq 150$ mm have the multi-groove system in the outer ring as standard. Bearings with an outside diameter $D < 150$ mm can be supplied with the multi-groove system on request (designation suffix ESL).

²⁾ Can only be relubricated via the outer ring.

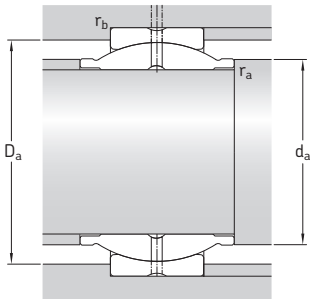

Dimensions

Abutment and fillet dimensions

d	d _k	d ₁	b	b ₁	M	r ₁ min	r ₂ min	d _a min	d _a max	D _a min	D _a max	r _a max	r _b max
mm								mm					
12	18	15,5	2,3	–	1,5	0,3	0,3	14,5	15,5	17,1	20,4	0,3	0,3
16	23	20	2,3	2,3	1,5	0,3	0,3	18,7	20	21,9	26,3	0,3	0,3
20	29	25	3,1	3,1	2	0,3	0,3	23,1	25	27,6	33,2	0,3	0,3
	29	24	3,1	3,1	2	0,3	0,3	23	24	30,9	33,2	0,3	0,3
25	35,5	30,5	3,1	3,1	2	0,6	0,6	29,2	30,5	33,7	39,2	0,6	0,6
	35,5	29	3,1	3,1	2	0,3	0,6	28,3	29	36,9	39,2	0,3	0,6
30	40,7	34	3,1	3,1	2	0,3	0,6	33,5	34	41,3	44	0,3	0,6
32	43	38	3,9	3,9	2,5	0,6	1	36,3	38	40,9	48,1	0,6	1
35	47	40	3,9	3,9	2,5	0,6	1	38,8	40	48,5	50,9	0,6	1
40	53	45	3,9	3,9	2,5	0,6	1	44	45	54,5	57,8	0,6	1
	53	46	3,9	3,9	2,5	0,6	1	44,8	46	50,3	57,8	0,6	1
45	60	52	4,6	4,6	3	0,6	1	49,6	52	61	63,6	0,6	1
50	66	57	4,6	4,6	3	0,6	1	54,8	57	66,2	70,5	0,6	1
	66	57	4,6	4,6	3	0,6	1	55,9	57	62,7	70,5	0,6	1
60	80	68	6,2	6,2	4	0,6	1	65,4	68	79,7	84,2	0,6	1
63	83	71,5	6,2	6,2	4	1	1	69,7	71,5	78,9	89,2	1	1
70	92	78	7,7	7,7	4	0,6	1	75,7	78	92	99	0,6	1
80	105	90	7,7	7,7	4	0,6	1	86,1	90	104,4	113,8	0,6	1
	105	91	7,7	7,7	4	1	1	88,7	91	99,7	113,8	1	1
100	130	113	11,3	11,3	5	1	1	110,1	113	123,5	143,2	1	1
125	160	138	13,5	13,5	6	1	1	136,5	138	152	172	1	1

Radial spherical plain bearings with an extended inner ring, steel/steel, metric sizes
d 160 – 200 mm

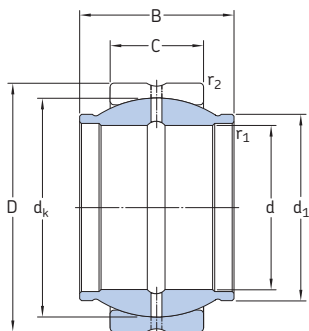

GEG .. ES

Principal dimensions				Angle of tilt	Basic load ratings		Mass	Designation ¹⁾ without seals
d	D	B	C	α	dynamic	static		
mm				degrees	kN		kg	–
160	230	160	80	4	1 370	6 800	16,5	GEG 160 ES
200	290	200	100	4	2 120	10 600	32,0	GEG 200 ES

¹⁾ Bearings with an outside diameter $D \geq 150$ mm have the multi-groove system in the outer ring as standard.

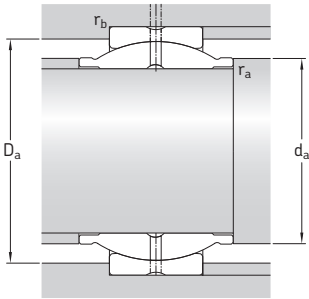

Dimensions
Abutment and fillet dimensions

d	d _k	d ₁	b	b ₁	M	r ₁ min	r ₂ min	d _a min	d _a max	D _a min	D _a max	r _a max	r _b max
mm								mm					
160	200	177	13,5	13,5	6	1	1	172	177	190	222	1	1
200	250	221	15,5	15,5	7	1,1	1,1	213	221	237,5	279,5	1	1

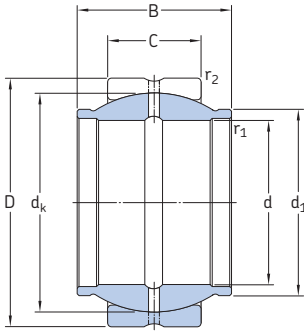
Radial spherical plain bearings with an extended inner ring, steel/steel, inch sizes
d 0.5 – 2.5 in

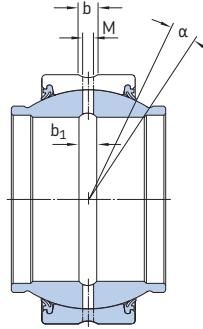

GEZM .. ES



GEZM .. ES-2RS

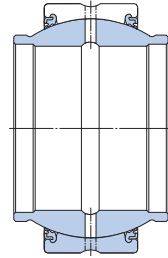

GEZM .. ES-2LS

Principal dimensions				Angle of tilt ¹⁾		Basic load ratings		Mass	Designations	suffix for seal variants	
d	D	B	C	α	α sealed	C	C ₀		without seals	standard	heavy-duty
in/mm				degrees		lbf/kN		lb/kg	-		
0.5 12,700	0.8750 22,225	0.750 19,05	0.375 9,53	9	-	3 150 14	9 340 41,5	0.051 0,023	GEZM 008 ES	-	-
0.625 15,875	1.0625 26,988	0.937 23,80	0.469 11,91	9	-	4 840 21,5	14 738 65,5	0.090 0,041	GEZM 010 ES	-	-
0.75 19,050	1.2500 31,750	1.125 28,58	0.562 14,28	9	5	7 090 31,5	20 925 93	0.15 0,068	GEZM 012 ES	-2RS	-
0.875 22,225	1.4375 36,513	1.312 33,33	0.656 16,66	9	-	9 560 42,5	28 575 127	0.23 0,11	GEZM 014 ES	-	-
1 25,400	1.6250 41,275	1.500 38,10	0.750 19,05	9	5	12 600 56	37 350 166	0.34 0,15	GEZM 100 ES	-2RS	-2LS
1.25 31,750	2.0000 50,800	1.875 47,63	0.937 23,80	9	5	19 460 86,5	58 500 260	0.63 0,29	GEZM 104 ES	-2RS	-2LS
1.375 34,925	2.1875 55,563	2.062 52,38	1.031 26,19	9	5	23 400 104	69 750 310	0.81 0,37	GEZM 106 ES	-2RS	-2LS
1.5 38,100	2.4375 61,913	2.250 57,15	1.125 28,58	9	5	28 130 125	84 380 375	1.15 0,51	GEZM 108 ES	-2RS	-2LS
1.75 44,450	2.8125 71,438	2.625 66,68	1.312 33,33	9	5	38 250 170	114 750 510	1.80 0,81	GEZM 112 ES	-2RS	-2LS
2 50,800	3.1875 80,963	3.000 76,20	1.500 38,10	9	5	50 400 224	150 750 670	2.65 1,20	GEZM 200 ES	-2RS	-2LS
2.25 57,150	3.5625 90,488	3.375 85,73	1.687 42,85	9	5	63 000 280	191 250 850	3.65 1,65	GEZM 204 ES	-2RS	-2LS
2.5 63,500	3.9375 100,013	3.750 95,25	1.875 47,63	9	5	77 625 350	234 000 1 040	4.95 2,25	GEZM 208 ES	-2RS	-2LS

¹⁾ To fully utilize the angle of tilt, the shaft shoulder should not be larger than $d_{a \max}$.

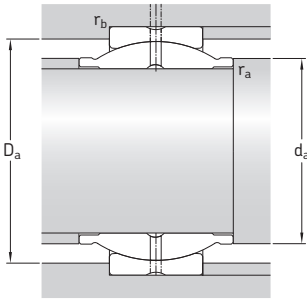

Dimensions

Abutment and fillet dimensions

d	d _k	d ₁	b	b ₁	M	r ₁ ¹⁾ min	r ₂ ²⁾ min	d _a min	d _a max	D _a min	D _a sealed min	D _a max	r _a max	r _b max
in/mm								in/mm						
0.5 12,700	0.7190 18,263	0.625 15,9	0.102 2,6	0.098 2,5	0.059 1,5	0.012 0,3	0.024 0,6	0.56 14,3	0.63 15,9	0.68 17,3	– –	0.78 19,9	0.012 0,3	0.024 0,6
0.625 15,875	0.8990 22,835	0.780 19,8	0.126 3,2	0.118 3	0.098 2,5	0.024 0,6	0.039 1,0	0.72 18,4	0.78 19,8	0.85 21,7	– –	0.93 23,6	0.024 0,6	0.039 1
0.75 19,050	1.0800 27,432	0.920 23,4	0.126 3,2	0.118 3	0.098 2,5	0.024 0,6	0.039 1,0	0.85 21,7	0.92 23,4	1.03 26,1	1.1 27,9	1.11 28,3	0.024 0,6	0.039 1
0.875 22,225	1.2580 31,953	1.070 27,2	0.126 3,2	0.118 3	0.098 2,5	0.024 0,6	0.039 1,0	0.98 24,9	1.07 27,2	1.2 30,4	– –	1.30 33	0.024 0,6	0.039 1
1 25,400	1.4370 36,500	1.220 31,0	0.126 3,2	0.118 3	0.098 2,5	0.024 0,6	0.039 1,0	1.11 28,2	1.22 31	1.37 34,7	1.39 35,2	1.48 37,7	0.024 0,6	0.039 1
1.25 31,750	1.7950 45,593	1.525 38,7	0.189 4,8	0.197 5	0.157 4	0.039 1,0	0.039 1,0	1.41 35,8	1.53 38,7	1.7 43,3	1.76 44,8	1.85 47	0.039 1	0.039 1
1.375 34,925	1.9370 49,200	1.670 42,4	0.189 4,8	0.197 5	0.157 4	0.039 1,0	0.039 1,0	1.54 39,1	1.67 42,4	1.84 46,7	1.85 47,1	2.04 51,7	0.039 1	0.039 1
1.5 38,100	2.1550 54,737	1.850 47,0	0.189 4,8	0.197 5	0.157 4	0.039 1,0	0.039 1,0	1.71 43,3	1.85 47	2.05 52	2.06 52,3	2.28 58	0.039 1	0.039 1
1.75 44,450	2.5150 63,881	2.165 55,0	0.189 4,8	0.197 5	0.157 4	0.039 1,0	0.039 1,0	1.97 49,9	2.17 55	2.39 60,7	2.41 61,3	2.65 67,4	0.039 1	0.039 1
2 50,800	2.8750 73,025	2.460 62,5	0.189 4,8	0.197 5	0.157 4	0.039 1,0	0.039 1,0	2.22 56,5	2.46 62,5	2.73 69,4	2.85 72,4	2.99 75,9	0.039 1	0.039 1
2.25 57,150	3.2350 82,169	2.760 70,1	0.224 5,7	0.197 5	0.157 4	0.039 1,0	0.039 1,0	2.48 63,1	2.76 70,1	3.07 78,1	3.11 79	3.36 85,3	0.039 1	0.039 1
2.5 63,500	3.5900 91,186	3.060 77,7	0.354 9	0.315 8	0.256 6,5	0.039 1,0	0.039 1,0	2.74 69,6	3.06 77,7	3.41 86,6	3.43 87	3.73 94,7	0.039 1	0.039 1

¹⁾ Equal to maximum shaft fillet radius $r_{a \max}$.

²⁾ Equal to maximum housing fillet radius $r_{b \max}$.

Radial spherical plain bearings with an extended inner ring, steel/steel, inch sizes
d 2.75 – 6 in

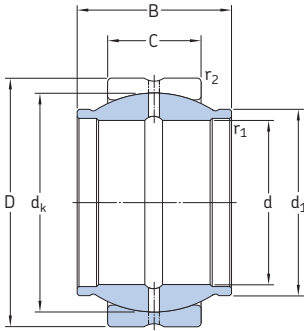

GEZM .. ES

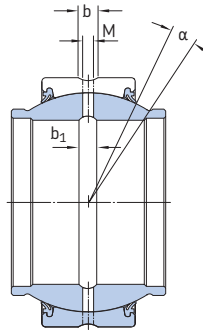

GEZM .. ES-2RS

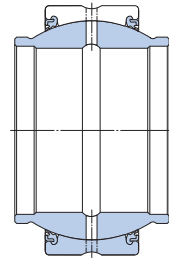

GEZM .. ES-2LS

Principal dimensions				Angle of tilt ¹⁾		Basic load ratings		Mass	Designations		
d	D	B	C	α	α_{sealed}	C	C ₀		without seals	suffix for seal variants	
in/mm				degrees		lbf/kN		lb/kg	-		
2.75 69,850	4.3750 111,125	4.125 104,78	2.062 52,38	9	5	95 625 430	285 750 1 270	6.85 3,10	GEZM 212 ES	-2RS	-2LS
3 76,200	4.7500 120,650	4.500 114,30	2.250 57,15	9	5	112 500 500	337 500 1 500	8.80 4,00	GEZM 300 ES	-2RS	-2LS
3.25 82,550	5.1250 130,175	4.875 123,83	2.437 61,90	9	5	131 625 590	396 000 1 760	11.0 5,00	GEZM 304 ES	-2RS	-2LS
3.5 88,900	5.5000 139,700	5.250 133,35	2.625 66,68	9	5	153 000 680	459 000 2 040	14.0 6,25	GEZM 308 ES	-2RS	-2LS
3.75 95,250	5.8750 149,225	5.625 142,88	2.812 71,43	9	5	175 500 780	531 000 2 360	17.0 7,60	GEZM 312 ES	-2RS	-2LS
4 101,600	6.2500 158,750	6.000 152,40	3.000 76,20	9	5	202 500 900	596 250 2 650	20.0 9,10	GEZM 400 ES	-2RS	-2LS
4.5 114,300	7.0000 177,800	6.750 171,45	3.375 85,73	7	5	252 000 1 120	765 000 3 400	28.5 13,0	GEZM 408 ES	-2RS	-2LS
5 127,000	7.7500 196,850	7.500 190,50	3.750 95,25	7	5	315 000 1 400	933 750 4 150	38.5 17,5	GEZM 500 ES	-2RS	-2LS
6 152,400	8.7500 222,250	8.250 209,55	4.125 104,78	7	5	389 250 1 730	1 170 000 5 200	47.5 21,5	GEZM 600 ES	-2RS	-2LS

¹⁾ To fully utilize the angle of tilt, the shaft shoulder should not be larger than $d_{a \text{ max}}$.

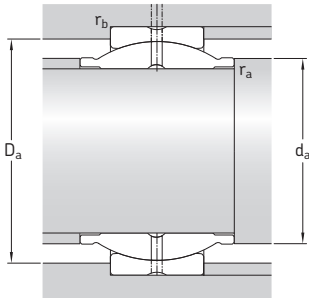

Dimensions

Abutment and fillet dimensions

d	d _k	d ₁	b	b ₁	M	r ₁ ¹⁾ min	r ₂ ²⁾ min	d _a min	d _a max	D _a min	D _a sealed min	D _a max	r _a max	r _b max
in/mm								in/mm						
2.75 69,850	3.9500 100,330	3.380 85,9	0.354 9	0.315 8	0.256 6,5	0.039 1,0	0.039 1,0	3.00 76,2	3.38 85,9	3.75 95,3	3.78 96	4.16 105,7	0.039 1	0.039 1
3 76,200	4.3120 109,525	3.675 93,3	0.354 9	0.315 8	0.256 6,5	0.039 1,0	0.039 1,0	3.26 82,8	3.68 93,3	4.09 104	4.13 104,8	4.53 115	0.039 1	0.039 1
3.25 82,550	4.6750 118,745	3.985 101,2	0.366 9,3	0.315 8	0.256 6,5	0.039 1,0	0.039 1,0	3.52 89,4	3.99 101,2	4.44 112,8	4.5 114,2	4.90 124,4	0.039 1	0.039 1
3.5 88,900	5.0400 128,016	4.300 109,2	0.413 10,5	0.315 8	0.256 6,5	0.039 1,0	0.039 1,0	3.78 95,9	4.3 109,2	4.79 121,6	4.83 122,8	5.27 133,8	0.039 1	0.039 1
3.75 95,250	5.3900 136,906	4.590 116,6	0.413 10,5	0.315 8	0.256 6,5	0.039 1,0	0.039 1,0	4.04 102,5	4.59 116,6	5.12 130,1	5.17 131,4	5.63 143,1	0.039 1	0.039 1
4 101,600	5.7500 146,050	4.905 124,6	0.413 10,5	0.394 10	0.315 8	0.059 1,5	0.039 1,0	4.33 110	4.91 124,6	5.47 139	5.49 139,5	6.00 152,5	0.059 1,5	0.039 1
4.5 114,300	6.4750 164,465	5.525 140,3	0.433 11	0.394 10	0.315 8	0.079 2,0	0.043 1,1	4.94 125,5	5.53 140,3	6.16 156,5	6.18 157	6.73 171	0.079 2	0.043 1,1
5 127,000	7.1900 182,626	6.130 155,7	0.433 11	0.394 10	0.315 8	0.079 2,0	0.043 1,1	5.45 138,5	6.13 155,7	6.83 173,5	6.91 175,5	7.42 188,5	0.079 2	0.043 1,1
6 152,400	8.1560 207,162	7.020 178,3	0.591 15	0.433 11	0.315 8	0.079 2,0	0.043 1,1	6.46 164	7.02 178,3	7.76 197	7.78 197,5	8.41 213,5	0.079 2	0.043 1,1

¹⁾ Equal to maximum shaft fillet radius $r_{a \max}$.

²⁾ Equal to maximum housing fillet radius $r_{b \max}$.



Maintenance-free radial spherical plain bearings

Dimensions	126
Tolerances	126
Radial internal clearance, preload	130
Materials	130
Permissible operating temperature range	130
Product tables	132
3.1 Maintenance-free radial spherical plain bearings, steel/PTFE sintered bronze, metric sizes	132
3.2 Maintenance-free radial spherical plain bearings, steel/PTFE fabric, metric sizes	134
3.3 Maintenance-free radial spherical plain bearings, steel/PTFE fabric, inch sizes	140
3.4 Maintenance-free radial spherical plain bearings, steel/PTFE FRP, metric sizes	144

Maintenance-free radial spherical plain bearings

SKF manufactures maintenance-free radial spherical plain bearings in a variety of designs and a wide range of sizes. Three sliding contact surface combinations are available:

- Steel/PTFE sintered bronze, designation suffix C
- Steel/PTFE fabric, designation suffix TX
- Steel/PTFE FRP, designation suffix F

All three sliding contact surface combinations are self-lubricating. Bearings with a steel/PTFE sintered bronze or steel/PTFE fabric sliding contact surface combinations must not be lubricated. Bearings with a steel/PTFE FRP (fibre reinforced polymer) sliding contact surface combination are also maintenance-free; however, occasional relubrication is beneficial to help maximize bearing service life. To facilitate relubrication, steel/PTFE FRP bearings are equipped with lubrication facilities.

The different designs of SKF maintenance-free radial spherical plain bearings are listed in **table 3** on **pages 128 to 129**. Their design depends on the size and series, with the main differences being the material or the design of the outer ring.

Dimensions

The dimensions of metric maintenance-free radial spherical plain bearings are in accordance with ISO 12240-1:1998. The dimensions of inch bearings in the GEZ series are in accordance with ANSI/ABMA Std. 22.2-1988.

Tolerances

The dimensional tolerances for metric maintenance-free radial spherical plain bearings are in accordance with ISO 12240-1:1998 and listed in **table 1**.

The dimensional tolerances for inch bearings in the GEZ series are in accordance with ANSI/ABMA Std. 22.2-1988 and listed in **table 2**. The symbols used are explained in the following:

d	nominal bore diameter
Δ_{dmp}	deviation of the mean bore diameter from the nominal
D	nominal outside diameter
Δ_{Dmp}	deviation of the mean outside diameter from the nominal
Δ_{Bs}	deviation of the single inner ring width from the nominal
Δ_{Cs}	deviation of the single outer ring width from the nominal

For the TX and TXG3 designs, outer ring tolerances apply to dimensions before fracture.

Table 1

Dimensional tolerances for metric maintenance-free radial spherical plain bearings

Nominal diameter d, D over		Inner ring Δ_{dmp} high		Δ_{Bs} high		Outer ring Δ_{Dmp} high		Δ_{Cs} high	
incl.		low	low	low	low	low	low	low	low
mm		μm		μm		μm		μm	
–	18	0	–8	0	–120	0	–8	0	–240
18	30	0	–10	0	–120	0	–9	0	–240
30	50	0	–12	0	–120	0	–11	0	–240
50	80	0	–15	0	–150	0	–13	0	–300
80	120	0	–20	0	–200	0	–15	0	–400
120	150	0	–25	0	–250	0	–18	0	–500
150	180	0	–25	0	–250	0	–25	0	–500
180	250	0	–30	0	–300	0	–30	0	–600
250	315	0	–35	0	–350	0	–35	0	–700
315	400	0	–40	0	–400	0	–40	0	–800
400	500	0	–45	0	–450	0	–45	0	–900
500	630	0	–50	0	–500	0	–50	0	–1 000
630	800	0	–75	0	–750	0	–75	0	–1 100
800	1 000	0	–100	0	–1 000	0	–100	0	–1 200
1 000	1 250	0	–125	0	–1 250	0	–125	0	–1 300
1 250	1 600	–	–	–	–	0	–160	0	–1 600
1 600	2 000	–	–	–	–	0	–200	0	–2 000

Table 2

Dimensional tolerances for inch maintenance-free radial spherical plain bearings

Nominal diameter d, D over		Inner ring Δ_{dmp} high		Δ_{Bs} high		Outer ring Δ_{Dmp} high		Δ_{Cs} high	
incl.		low	low	low	low	low	low	low	low
in		μm		μm		μm		μm	
–	2	0	–13	0	–130	0	–13	0	–130
2	3	0	–15	0	–130	0	–15	0	–130
3	3.1875	0	–20	0	–130	0	–15	0	–130
3.1875	4.75	0	–20	0	–130	0	–20	0	–130
4.75	6	0	–25	0	–130	0	–25	0	–130
6	7	–	–	–	–	0	–25	0	–130
7	8.75	–	–	–	–	0	–30	0	–130

Design of maintenance-free radial spherical plain bearings

Sliding contact surface combination

Steel/PTFE sintered bronze

Steel/PTFE fabric

Steel/PTFE FRP

Lining



- 1 PTFE
- 2 Tin bronze
- 3 Sheet steel backing

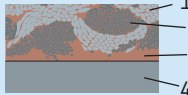

- 1 PTFE fibres
- 2 Reinforcement fibres
- 3 Resin
- 4 Steel backing



- 1 Fibres
- 2 Polymer and PTFE
- 3 Steel backing

Inner ring

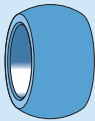

C and CJ2 designs

Bearing steel, through-hardened and ground, sliding surface hard chromium plated

TXA and TXE designs

Bearing steel, through-hardened and ground, sliding surface hard chromium plated

Series GEP and GEC

Bearing steel, through-hardened, ground, sliding surface hard chromium plated

TXGR, TXG3E and TXG3A designs

Stainless steel
X 46 Cr 13/1.4034, hardened, ground

Outer ring



C design

Steel backing with PTFE sintered bronze layer pressed around the inner ring, with a butt joint

CJ2 design

Steel backing with PTFE sintered bronze sleeve pressed around the inner ring, without a butt joint

TXA and TXE designs

Bearing steel, through-hardened and ground

TXA: axially split, held together by one or two bands or bolted together

TXE: fractured at one point

Series GEP and GEC

Hardenable steel, ground, FRP shells are retained by side flanges and also glued to the outer ring

Series GEP: radially split, separable

Series GEC: axially split, held together by two bands ($d \leq 400$ mm) or bolted together ($d > 400$ mm)

TXG3A and TXG3E design

Stainless steel
X 46 Cr 13/1.4034, hardened, ground,
TXG3A: axially split, held together by one or two bands



TXG3E: fractured at one point

TXGR design

Unhardened stainless steel
X 17 CrNi 16-2 or equivalent, pressed around the inner ring, no butt joint

Table 3

Design of maintenance-free radial spherical plain bearings

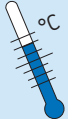
Sliding contact surface combination	Steel/PTFE sintered bronze	Steel/PTFE fabric	Steel/PTFE FRP
Seals RS design  LS design 	Available on request	Bearings with designation suffix -2RS or -2LS (depending on bearing size) have a double- or triple-lip seal on both sides (→ page 79)	None
Permissible operating temperature range 	-50 to +150 °C, for short periods up to +280 °C Reduced carrying capacity above 80 °C	Bearings without seals: -50 to +150 °C Bearings with RS seals: with a bore diameter $d < 320$ mm: -30 to +130 °C with a bore diameter $d \geq 320$ mm: -35 to +100 °C Bearings with LS seals: -50 to +110 °C Reduced carrying capacity above 65 °C for both sealed and unsealed bearings	-40 to +75 °C, for short periods up to +110 °C Reduced carrying capacity above 50 °C
Lubrication (refer to the section <i>Lubrication</i> , starting on page 84)	Self-lubricating; the bearings must not be lubricated	Self-lubricating; the bearings must not be lubricated	Greased before leaving factory, self-lubricating capability, however occasional relubrication extends service life

Maintenance-free radial spherical plain bearings

Radial internal clearance, preload

Maintenance-free radial spherical plain bearings with a bore diameter $d \leq 90$ mm either have an internal clearance or a slight preload (negative clearance) depending on their design. Therefore, these bearings can only be provided with an upper limit for bearing internal clearance. The lower limit must be assessed by the frictional moment, resulting from the preload (negative clearance).

The radial internal clearance and the upper limit of the permissible frictional moment of bearings with a steel/PTFE sintered bronze sliding contact surface are listed in **table 4**. The values for the clearance limits of bearings with a steel/PTFE fabric and a steel/PTFE FRP sliding contact surface combination are listed in **tables 5 to 8**.

Materials

The materials for the inner ring, outer ring, sliding layer and seals, where applicable, are listed in **table 3** on **pages 128 to 129**.

Permissible operating temperature range

The permissible operating temperature range of maintenance-free radial spherical plain bearings depends on the sliding contact surface combination and the material of the seals (→ **table 3** on **pages 128 to 129**). However, if the load carrying capacity of the bearings is to be fully exploited, the temperature range must be narrowed. Depending on the application, it is possible to operate at temperatures above the upper limit for brief periods. For additional information, contact the SKF application engineering service.

Table 4

Radial internal clearance and frictional moment of steel/PTFE sintered bronze bearings, metric sizes

Nominal diameter d		Radial internal clearance max	Frictional moment max
over	incl.		
mm		μm	Nm

Series GE .. C, CJ2

2,5	12	28	0,15
12	20	35	0,25
20	30	44	0,40
30	60	53	0,75

Series GEH .. C

2,5	10	28	0,15
10	17	35	0,25
17	25	44	0,40

Table 5

Radial internal clearance for steel/PTFE fabric bearings, metric sizes

Nominal diameter d		Radial internal clearance	
over	incl.	min	max
mm		μm	

Series

GE .. TXA, TXE, TXGR, TXG3A, TXG3E
GEH¹⁾, TXA, TXE, TXG3A, TXG3E
GEC .. TXA

12	12	–	50
20	20	–	50
20	30	–	50
30	60	–	50
60	90	–	50
90	140	50	130
140	180	50	140
180	300	80	190
300	460	100	230
460	530	100	245
530	670	100	260
670	800	100	270

¹⁾ Bearings in the GEH .. TX.. series with a bore diameter $d = 90$ mm have a radial clearance corresponding to the values quoted for the next larger diameter.

Table 6

Radial internal clearance for steel/PTFE fabric bearings, inch sizes

Nominal diameter d		Radial internal clearance	
over	incl.	min	max
in		µm	

Series GEZ .. TXE, TXA

–	3	–	50
3	4.75	50	130
4.75		50	140

Table 7

Radial internal clearance for steel/PTFE FRP bearings, metric sizes

Bore diameter d		Radial internal clearance	
over	incl.	min	max
mm		µm	

Series GEP .. FS

90	120	85	285
120	180	100	335
180	220	100	355
220	240	110	365
240	280	110	380
280	300	135	415
300	380	135	490
380	400	135	510
400	480	145	550
480	500	145	570
500	600	160	610
600	630	160	640
630	750	170	670
750	800	170	700
800	950	195	770
950	1 000	195	820

Table 8

Radial internal clearance for steel/PTFE FRP bearings, metric sizes

Nominal diameter d		Radial internal clearance	
over	incl.	min	max
mm		µm	

Series GEC .. FBAS

300	340	135	350
340	400	135	360
400	500	145	390
500	530	160	420
530	630	160	440
630	670	170	460
670	800	170	490
800	850	195	530
850	1 000	195	560

Maintenance-free radial spherical plain bearings, steel/PTFE sintered bronze, metric sizes
d 4 – 60 mm

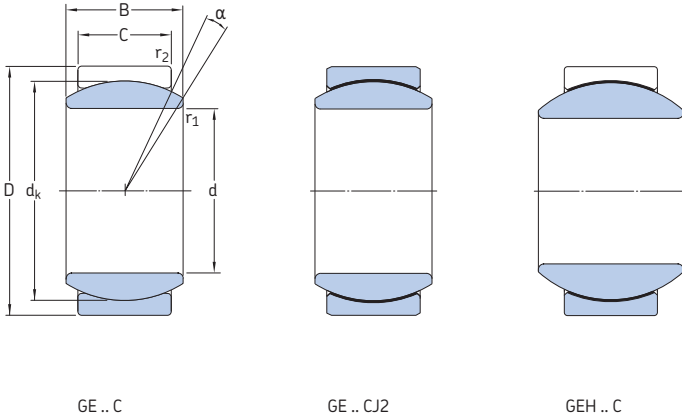

Principal dimensions				Angle of tilt ¹⁾ α	Basic load ratings		Mass	Designation
d	D	B	C		dynamic	static		
mm				degrees	C	C ₀	kg	–
4	12	5	3	16	2,16	5,4	0,003	GE 4 C
6	14	6	4	13	3,6	9	0,004	GE 6 C
8	16	8	5	15	5,85	14,6	0,008	GE 8 C
10	19	9	6	12	8,65	21,6	0,012	GE 10 C
	22	12	7	18	11,4	28,5	0,020	GEH 10 C
12	22	10	7	10	11,4	28,5	0,017	GE 12 C
	26	15	9	18	18	45	0,030	GEH 12 C
15	26	12	9	8	18	45	0,032	GE 15 C
	30	16	10	16	22,4	56	0,050	GEH 15 C
17	30	14	10	10	22,4	56	0,050	GE 17 C
	35	20	12	19	31,5	78	0,090	GEH 17 C
20	35	16	12	9	31,5	78	0,065	GE 20 C
	42	25	16	17	51	127	0,16	GEH 20 C
25	42	20	16	7	51	127	0,12	GE 25 C
	47	28	18	17	65,5	166	0,20	GEH 25 C
30	47	22	18	6	65,5	166	0,16	GE 30 C
35	55	25	20	6	80	200	0,23	GE 35 CJ2
40	62	28	22	7	100	250	0,32	GE 40 CJ2
45	68	32	25	7	127	320	0,46	GE 45 CJ2
50	75	35	28	6	156	390	0,56	GE 50 CJ2
60	90	44	36	6	245	610	1,10	GE 60 CJ2

¹⁾ To fully utilize the angle of tilt, the shaft shoulder should not be larger than $d_{a \max}$.

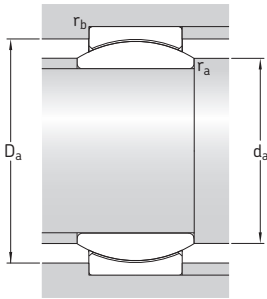

Dimensions

Abutment and fillet dimensions

d	d _k	r ₁ min	r ₂ min	d _a min	d _a max	D _a min	D _a max	r _a max	r _b max
mm				mm					
4	8	0,3	0,3	5,4	6,2	7,6	10,7	0,3	0,3
6	10	0,3	0,3	7,4	8	9,5	12,7	0,3	0,3
8	13	0,3	0,3	9,4	10,2	12,3	14,6	0,3	0,3
10	16	0,3	0,3	11,5	13,2	15,2	17,6	0,3	0,3
	18	0,3	0,3	11,6	13,4	17,1	20,6	0,3	0,3
12	18	0,3	0,3	13,5	15	17,1	20,6	0,3	0,3
	22	0,3	0,3	13,7	16,1	20,9	24,5	0,3	0,3
15	22	0,3	0,3	16,6	18,4	20,9	24,5	0,3	0,3
	25	0,3	0,3	16,7	19,2	23,7	28,5	0,3	0,3
17	25	0,3	0,3	18,7	20,7	23,7	28,5	0,3	0,3
	29	0,3	0,3	18,9	21	27,6	33,4	0,3	0,3
20	29	0,3	0,3	21,8	24,2	27,6	33,4	0,3	0,3
	35,5	0,3	0,6	22,1	25,2	33,7	39,5	0,3	0,6
25	35,5	0,6	0,6	27,7	29,3	33,7	39,5	0,6	0,6
	40,7	0,6	0,6	27,9	29,5	38,7	44,4	0,6	0,6
30	40,7	0,6	0,6	32,8	34,2	38,7	44,4	0,6	0,6
35	47	0,6	1	37,9	39,8	44,7	51,4	0,6	1
40	53	0,6	1	42,9	45	50,4	58,3	0,6	1
45	60	0,6	1	48,7	50,8	57	64,2	0,6	1
50	66	0,6	1	53,9	56	62,7	71,1	0,6	1
60	80	1	1	65,4	66,8	76	85,8	1	1

Maintenance-free radial spherical plain bearings, steel/PTFE fabric, metric sizes
d 12 – 90 mm

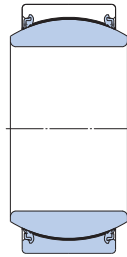
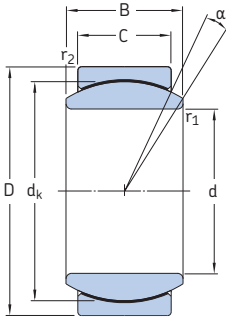

GE ..TXGR

GE ..TX(G3)E-2LS

GE ..TX(G3)A-2LS

Principal dimensions				Angle of tilt ¹⁾ α	Basic load ratings		Mass	Designations Material Bearing steel	Stainless steel
d	D	B	C		C	C ₀			
mm				degrees	kN		kg	–	
12	22	10	7	10	30	50	0,017	–	GE 12 TXGR
15	26	12	9	8	47,5	80	0,032	–	GE 15 TXGR
17	30	14	10	10	60	100	0,050	–	GE 17 TXGR
20	35	16	12	9	83	140	0,065	GE 20 TXE-2LS GEH 20 TXE-2LS	GE 20 TXG3E-2LS GEH 20 TXG3E-2LS
	42	25	16	17	137	228	0,15		
25	42	20	16	7	137	228	0,12	GE 25 TXE-2LS GEH 25 TXE-2LS	GE 25 TXG3E-2LS GEH 25 TXG3E-2LS
	47	28	18	17	176	290	0,19		
30	47	22	18	6	176	290	0,16	GE 30 TXE-2LS GEH 30 TXE-2LS	GE 30 TXG3E-2LS GEH 30 TXG3E-2LS
	55	32	20	17	224	375	0,29		
35	55	25	20	6	224	375	0,23	GE 35 TXE-2LS GEH 35 TXE-2LS	GE 35 TXG3E-2LS GEH 35 TXG3E-2LS
	62	35	22	15	280	465	0,39		
40	62	28	22	6	280	465	0,32	GE 40 TXE-2LS GEH 40 TXE-2LS	GE 40 TXG3E-2LS GEH 40 TXG3E-2LS
	68	40	25	17	360	600	0,52		
45	68	32	25	7	360	600	0,46	GE 45 TXE-2LS GEH 45 TXE-2LS	GE 45 TXG3E-2LS GEH 45 TXG3E-2LS
	75	43	28	14	440	735	0,69		
50	75	35	28	6	440	735	0,56	GE 50 TXE-2LS GEH 50 TXE-2LS	GE 50 TXG3E-2LS GEH 50 TXG3E-2LS
	90	56	36	17	695	1160	1,41		
60	90	44	36	6	695	1160	1,10	GE 60 TXE-2LS GEH 60 TXE-2LS	GE 60 TXG3E-2LS GEH 60 TXG3E-2LS
	105	63	40	17	880	1460	2,06		
70	105	49	40	6	880	1460	1,55	GE 70 TXE-2LS GEH 70 TXE-2LS	GE 70 TXG3A-2LS GEH 70 TXG3A-2LS
	120	70	45	16	1140	1900	2,99		
80	120	55	45	5	1140	1900	2,30	GE 80 TXE-2LS GEH 80 TXE-2LS	GE 80 TXG3A-2LS GEH 80 TXG3A-2LS
	130	75	50	14	1370	2320	3,55		
90	130	60	50	5	1370	2320	2,75	GE 90 TXE-2LS GEH 90 TXA-2LS	GE 90 TXG3A-2LS GEH 90 TXG3A-2LS
	150	85	55	15	1730	2850	5,40		

¹⁾ To fully utilize the angle of tilt, the shaft shoulder should not be larger than $d_{a\max}$.

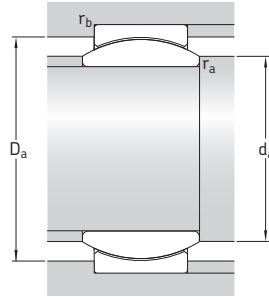
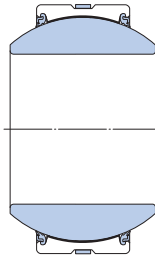
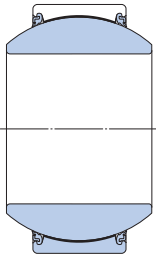

GEH..TX(G3)E-2LS

GEH..TX(G3)A-2LS

Dimensions**Abutment and fillet dimensions**

d	d _k	r ₁ min	r ₂ min	d _a min	d _a max	D _a min	D _a max	r _a max	r _b max
mm				mm					
12	18	0,3	0,3	13,8	15	17,1	20,4	0,3	0,3
15	22	0,3	0,3	16,9	18,4	20,9	24,3	0,3	0,3
17	25	0,3	0,3	19	20,7	23,7	28,3	0,3	0,3
20	29	0,3	0,3	22,1	24,2	27,6	33,2	0,3	0,3
	35,5	0,3	0,6	22,9	25,2	36,9	39,2	0,3	0,6
25	35,5	0,6	0,6	28,2	29,3	36,9	39,2	0,6	0,6
	40,7	0,6	0,6	28,7	29,5	41,3	44	0,6	0,6
30	40,7	0,6	0,6	33,3	34,2	41,3	44	0,6	0,6
	47	0,6	1	33,8	34,4	48,5	51	0,6	1
35	47	0,6	1	38,5	39,8	48,5	51	0,6	1
	53	0,6	1	39	39,7	54,5	57,5	0,6	1
40	53	0,6	1	43,5	45	54,5	57,5	0,6	1
	60	0,6	1	44,2	44,7	61	63,5	0,6	1
45	60	0,6	1	49,5	50,8	61	63,5	0,6	1
	66	0,6	1	50	50	66,5	70,5	0,6	1
50	66	0,6	1	54,5	56	66,5	70,5	0,6	1
	80	0,6	1	56	57,1	80	84	0,6	1
60	80	1	1	66,5	66,8	80	84	1	1
	92	1	1	67	67	92	99	1	1
70	92	1	1	76,5	77,9	92	99	1	1
	105	1	1	77,8	78,2	105	113	1	1
80	105	1	1	87	89,4	105	113	1	1
	115	1	1	87,1	87,1	113	123	1	1
90	115	1	1	97,5	98,1	113	123	1	1
	130	1	1	98,3	98,3	131	144	1	1

Maintenance-free radial spherical plain bearings, steel/PTFE fabric, metric sizes
d 100 – 300 mm

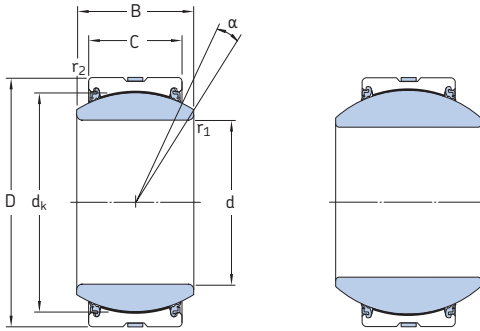

GE .. TX(G3)A-2LS

GEH .. TX(G3)A-2LS

Principal dimensions				Angle of tilt ¹⁾ α	Basic load ratings		Mass	Designations	
d	D	B	C		dynamic	static		Material	Bearing steel
mm				degrees	C	C_0	kg	–	Stainless steel
100	150	70	55	6	1 730	2 850	4,40	GE 100 TXA-2LS	GE 100 TXG3A-2LS
	160	85	55	13	1 860	3 100	5,90	GEH 100 TXA-2LS	GEH 100 TXG3A-2LS
110	160	70	55	6	1 860	3 100	4,80	GE 110 TXA-2LS	GE 110 TXG3A-2LS
	180	100	70	12	2 700	4 500	9,50	GEH 110 TXA-2LS	GEH 110 TXG3A-2LS
120	180	85	70	6	2 700	4 500	8,25	GE 120 TXA-2LS	GE 120 TXG3A-2LS
	210	115	70	16	3 000	5 000	14,90	GEH 120 TXA-2LS	GEH 120 TXG3A-2LS
140	210	90	70	7	3 000	5 000	11,0	GE 140 TXA-2LS	GE 140 TXG3A-2LS
160	230	105	80	8	3 800	6 400	14,0	GE 160 TXA-2LS	GE 160 TXG3A-2LS
180	260	105	80	6	4 300	7 200	18,5	GE 180 TXA-2LS	GE 180 TXG3A-2LS
200	290	130	100	7	6 000	10 000	28,0	GE 200 TXA-2LS	GE 200 TXG3A-2LS
220	320	135	100	8	6 550	11 000	35,5	GE 220 TXA-2LS	–
240	340	140	100	8	7 200	12 000	40,0	GE 240 TXA-2LS	–
260	370	150	110	7	8 650	14 300	51,5	GE 260 TXA-2LS	–
280	400	155	120	6	10 000	16 600	65,0	GE 280 TXA-2LS	–
300	430	165	120	7	10 800	18 000	78,5	GE 300 TXA-2LS	–

¹⁾ To fully utilize the angle of tilt, the shaft shoulder should not be larger than $d_{a \max}$.

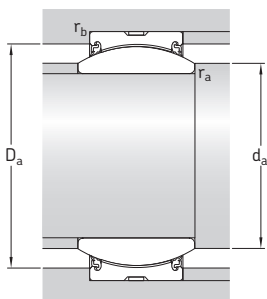

Dimensions

Abutment and fillet dimensions

d	d _k	r ₁ min	r ₂ min	d _a min	d _a max	D _a min	D _a max	r _a max	r _b max
mm				mm					
100	130	1	1	108	109,5	131	144	1	1
	140	1	1	108,5	111,2	141,5	153	1	1
110	140	1	1	118	121	141,5	153	1	1
	160	1	1	120	124,5	157,5	172	1	1
120	160	1	1	130	135,5	157,5	172	1	1
	180	1	1	130,5	138	180	202	1	1
140	180	1	1	149	155,5	180	202	1	1
160	200	1	1	170	170	197	222	1	1
180	225	1,1	1,1	191	199	224,5	250	1	1
200	250	1,1	1,1	213	213,5	244,5	279	1	1
220	275	1,1	1,1	233	239,5	271	309	1	1
240	300	1,1	1,1	253	265	298	329	1	1
260	325	1,1	1,1	273	288	321,5	359	1	1
280	350	1,1	1,1	294	313,5	344,5	388	1	1
300	375	1,1	1,1	314	336,5	371	418	1	1

Maintenance-free radial spherical plain bearings, steel/PTFE fabric, metric sizes
d 320 – 800 mm

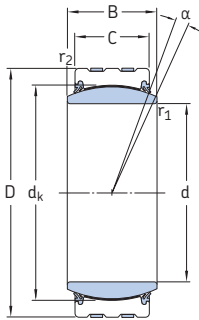

GEC ..TXA-2RS
d ≤ 400 mm

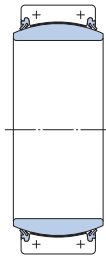

GEC ..TXA-2RS
d ≥ 420 mm

Principal dimensions				Angle of tilt ¹⁾	Basic load ratings		Mass	Designation
d	D	B	C		C	C ₀		
mm				degrees	kN		kg	–
320	440	160	135	4	14 000	23 200	75	GEC 320 TXA-2RS
340	460	160	135	3	14 600	24 500	82,5	GEC 340 TXA-2RS
360	480	160	135	3	15 300	25 500	84	GEC 360 TXA-2RS
380	520	190	160	4	19 300	32 500	125	GEC 380 TXA-2RS
400	540	190	160	3	20 400	34 000	130	GEC 400 TXA-2RS
420	560	190	160	3	21 200	35 500	140	GEC 420 TXA-2RS
440	600	218	185	3	26 000	43 000	195	GEC 440 TXA-2RS
460	620	218	185	3	27 000	45 000	200	GEC 460 TXA-2RS
480	650	230	195	3	30 000	50 000	235	GEC 480 TXA-2RS
500	670	230	195	3	31 000	51 000	245	GEC 500 TXA-2RS
530	710	243	205	3	34 500	57 000	290	GEC 530 TXA-2RS
560	750	258	215	3	38 000	63 000	340	GEC 560 TXA-2RS
600	800	272	230	3	43 000	72 000	405	GEC 600 TXA-2RS
630	850	300	260	3	52 000	86 500	525	GEC 630 TXA-2RS
670	900	308	260	3	55 000	91 500	590	GEC 670 TXA-2RS
710	950	325	275	3	62 000	102 000	685	GEC 710 TXA-2RS
750	1 000	335	280	3	65 500	110 000	770	GEC 750 TXA-2RS
800	1 060	355	300	3	75 000	125 000	910	GEC 800 TXA-2RS

¹⁾ To fully utilize the angle of tilt, the shaft shoulder should not be larger than $d_{a \max}$.

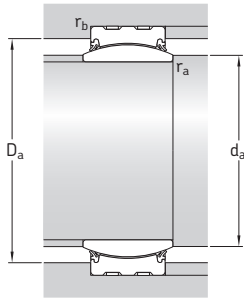

Dimensions

Abutment and fillet dimensions

d	d _k	r ₁ min	r ₂ min	d _a min	d _a max	D _a min	D _a max	r _a max	r _b max
mm				mm					
320	380	1,1	3	337	344	376	414	1	3
340	400	1,1	3	357	366	396	434	1	3
360	420	1,1	3	376	388	416	454	1	3
380	450	1,5	4	400	407	445	490	1,5	4
400	470	1,5	4	420	429	465	510	1,5	4
420	490	1,5	4	439	451	485	530	1,5	4
440	520	1,5	4	461	472	514	568	1,5	4
460	540	1,5	4	482	494	534	587	1,5	4
480	565	2	5	504	516	559	613	2	5
500	585	2	5	524	537	579	633	2	5
530	620	2	5	555	570	613	672	2	5
560	655	2	5	585	602	648	711	2	5
600	700	2	5	627	644	692	760	2	5
630	740	3	6	662	676	732	802	3	6
670	785	3	6	702	722	776	853	3	6
710	830	3	6	744	763	821	901	3	6
750	875	3	6	784	808	865	950	3	6
800	930	3	6	835	859	920	1008	3	6

Maintenance-free radial spherical plain bearings, steel/PTFE fabric, inch sizes
d 1 – 3.75 in

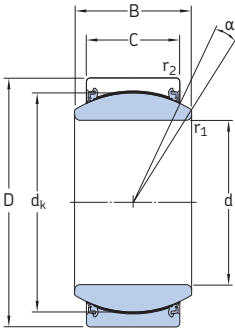

GEZ ..TXE-2LS

Principal dimensions				Angle of tilt	Basic load ratings		Mass	Designation
d	D	B	C	α	C	C_0		
in/mm				degrees	lbf/kN		lb/kg	–
1 25,400	1.6250 41,275	0.875 22,23	0.750 19,05	6	18 680 83	37 350 166	0.26 0,12	GEZ 100 TXE-2LS
1.25 31,750	2.0000 50,800	1.093 27,76	0.937 23,80	6	29 030 129	58 500 260	0.51 0,23	GEZ 104 TXE-2LS
1.375 34,925	2.1875 55,563	1.187 30,15	1.031 26,19	5	35 100 156	69 750 310	0.77 0,35	GEZ 106 TXE-2LS
1.5 38,100	2.4375 61,913	1.312 33,33	1.125 28,58	6	41 850 186	84 380 375	0.93 0,42	GEZ 108 TXE-2LS
1.75 44,450	2.8125 71,438	1.531 38,89	1.312 33,33	6	57 380 255	114 750 510	1.40 0,64	GEZ 112 TXE-2LS
2 50,800	3.1875 80,963	1.750 44,45	1.500 38,10	6	75 380 335	150 750 670	2.05 0,93	GEZ 200 TXE-2LS
2.25 57,150	3.5625 90,488	1.969 50,01	1.687 42,85	6	95 630 425	191 250 850	2.85 1,30	GEZ 204 TXE-2LS
2.5 63,500	3.9375 100,013	2.187 55,55	1.875 47,63	6	117 000 520	234 000 1 040	4.10 1,85	GEZ 208 TXE-2LS
2.75 69,850	4.3750 111,125	2.406 61,11	2.062 52,38	6	141 750 630	285 750 1 270	5.30 2,40	GEZ 212 TXE-2LS
3 76,200	4.75 120,650	2.625 66,68	2.25 57,15	6	168 750 750	337 500 1500	6.84 3,1	GEZ 300 TXE-2LS
3.25 82,550	5.125 130,175	2.844 72,24	2.437 61,9	6	198 000 880	396 000 1760	8.38 3,8	GEZ 304 TXE-2LS
3.5 88,900	5.5 139,700	3.062 77,78	2.625 66,68	6	229 500 1020	459 000 2040	10.58 4,8	GEZ 308 TXE-2LS
3.75 95,250	5.875 149,225	3.281 83,34	2.812 71,43	6	265 500 1180	531 000 2360	12.79 5,8	GEZ 312 TXE-2LS

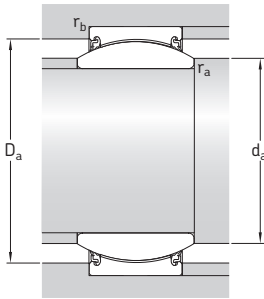

Dimensions

Abutment and fillet dimensions

d	d _k	r ₁ min	r ₂ min	d _a min	d _a max	D _a min	D _a max	r _a max	r _b max
in/mm		in/mm							
1 25,400	1.4370 36,500	0.012 0,3	0.039 1	1.09 27,6	1.14 28,9	1.45 36,8	1.46 37,1	0.012 0,3	0.039 1
1.25 31,750	1.7950 45,593	0.024 0,6	0.039 1	1.38 35	1.42 36,1	1.81 45,9	1.83 46,4	0.024 0,6	0.039 1
1.375 34,925	1.9370 49,200	0.024 0,6	0.039 1	1.51 38,3	1.53 38,8	1.93 49	2.01 51	0.024 0,6	0.039 1
1.5 38,100	2.1550 54,737	0.024 0,6	0.039 1	1.64 41,6	1.71 43,4	2.17 55,1	2.25 57,2	0.024 0,6	0.039 1
1.75 44,450	2.5150 63,881	0.024 0,6	0.039 1	1.92 48,8	1.99 50,6	2.52 64,1	2.62 66,5	0.024 0,6	0.039 1
2 50,800	2.8750 73,025	0.024 0,6	0.039 1	2.18 55,4	2.28 57,9	2.85 72,4	2.95 74,9	0.024 0,6	0.039 1
2.25 57,150	3.2350 82,169	0.024 0,6	0.039 1	2.44 62	2.56 65,1	3.22 81,9	3.31 84,1	0.024 0,6	0.039 1
2.5 63,500	3.5900 91,186	0.024 0,6	0.039 1	2.7 68,6	2.85 72,3	3.56 90,4	3.68 93,4	0.024 0,6	0.039 1
2.75 69,850	3.9500 100,330	0.024 0,6	0.039 1	2.96 75,2	3.13 79,5	3.95 100,4	4.1 104,2	0.024 0,6	0.039 1
3 76,200	4.3120 109,525	0.024 0,6	0.039 1	3.220 81,8	3.417 86,8	4.299 109,2	4.469 113,5	0.024 0,6	0.039 1
3.25 82,550	4.675 118,745	0.024 0,6	0.039 1	3.480 88,4	3.709 94,2	4.677 118,8	4.831 122,7	0.024 0,6	0.039 1
3.5 88,900	5.04 128,016	0.024 0,6	0.039 1	3.740 95	4.000 101,6	5.024 127,6	5.197 132	0.024 0,6	0.039 1
3.75 95,250	5.39 136,906	0.024 0,6	0.039 1	4.000 101,6	4.276 108,6	5.362 136,2	5.559 141,2	0.024 0,6	0.039 1

Maintenance-free radial spherical plain bearings, steel/PTFE fabric, inch sizes
d 4 – 6 in

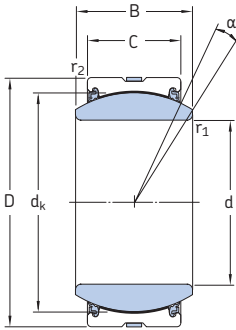

GEZ ..TXA-2LS

Principal dimensions				Angle of tilt	Basic load ratings		Mass	Designation
d	D	B	C	α	dynamic	static		
				degrees	C	C_0		
in/mm					lbf/kN		lb/kg	–
4	6.25	3.5	3	6	301 500	596 250	15.435	GEZ 400 TXA-2LS
101,600	158,750	88,9	76,2		1340	2650	7	
4.5	7	3.937	3.375	6	382 500	765 000	21.609	GEZ 408 TXA-2LS
114,300	177,800	100	85,725		1700	3400	9,8	
4.75	7.375	4.156	3.562	6	427 500	843 750	25.358	GEZ 412 TXA-2LS
120,650	187,325	105,56	90,48		1900	3750	11,5	
5	7.75	4.375	3.75	6	468 000	933 750	29.768	GEZ 500 TXA-2LS
127	196,850	111,13	95,25		2080	4150	13,5	
6	8.75	4.75	4.125	5	585 000	1 170 000	38.588	GEZ 600 TXA-2LS
152,400	222,250	120,65	104,78		2600	5200	17,5	

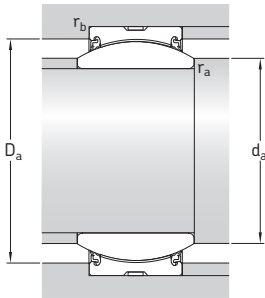

Dimensions

Abutment and fillet dimensions

d	d _k	r ₁ min	r ₂ min	d _a min	d _a max	D _a min	D _a max	r _a max	r _b max
in/mm		in/mm							
4	5.75	0.024	0.039	4.272	4.547	5.709	5.925	0.024	0.039
	101,600	0,6	1	108,5	115,5	145	150,5	0,6	1
4.5	6.475	0.039	0.043	4.843	5.138	6.358	6.634	0.039	0.043
	114,300	1	1,1	123	130,5	161,5	168,5	1	1,1
4.75	6.825	0.039	0.043	5.098	5.413	6.850	6.969	0.039	0.043
	120,650	1	1,1	129,5	137,5	174	177	1	1,1
5	7.19	0.039	0.043	5.354	5.689	7.106	7.323	0.039	0.043
	127	1	1,1	136	144,5	180,5	186	1	1,1
6	8.156	0.039	0.043	6.358	6.614	8.012	8.307	0.039	0.043
	152,400	1	1,1	161,5	168	203,5	211	1	1,1

Maintenance-free radial spherical plain bearings, steel/PTFE FRP, metric sizes
d 100 – 420 mm

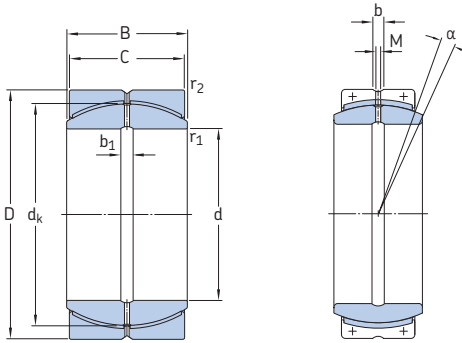

GEP .. FS

GEC .. FBAS

Principal dimensions				Angle of tilt	Basic load ratings		Mass	Designation
d	D	B	C	α	C	C_0		
mm				degrees	kN		kg	–
100	150	71	67	2	600	900	4,5	GEP 100 FS
110	160	78	74	2	720	1 080	5,35	GEP 110 FS
120	180	85	80	2	850	1 270	7,95	GEP 120 FS
140	210	100	95	2	1 200	1 800	13	GEP 140 FS
160	230	115	109	2	1 600	2 400	16,5	GEP 160 FS
180	260	128	122	2	2 080	3 100	24,5	GEP 180 FS
200	290	140	134	2	2 450	3 650	33,5	GEP 200 FS
220	320	155	148	2	3 050	4 550	46	GEP 220 FS
240	340	170	162	2	3 550	5 400	53,5	GEP 240 FS
260	370	185	175	2	4 250	6 400	69,5	GEP 260 FS
280	400	200	190	2	5 000	7 500	89,5	GEP 280 FS
300	430	212	200	2	5 600	8 300	110	GEP 300 FS
320	440	160	135	4	3 000	4 500	69,0	GEC 320 FBAS
	460	230	218	2	6 400	9 650	135	GEP 320 FS
340	460	160	135	3	3 150	4 750	73,0	GEC 340 FBAS
	480	243	230	2	7 100	10 800	150	GEP 340 FS
360	480	160	135	3	3 250	4 900	77,0	GEC 360 FBAS
	520	258	243	2	8 150	12 200	200	GEP 360 FS
380	520	190	160	4	4 300	6 550	116	GEC 380 FBAS
	540	272	258	2	9 150	13 700	220	GEP 380 FS
400	540	190	160	3	4 500	6 700	120	GEC 400 FBAS
	580	280	265	2	9 650	14 600	275	GEP 400 FS
420	560	190	160	3	4 650	6 950	126	GEC 420 FBAS
	600	300	280	2	10 600	16 000	300	GEP 420 FS

Maintenance-free radial spherical plain bearings, steel/PTFE FRP, metric sizes
d 440 – 850 mm

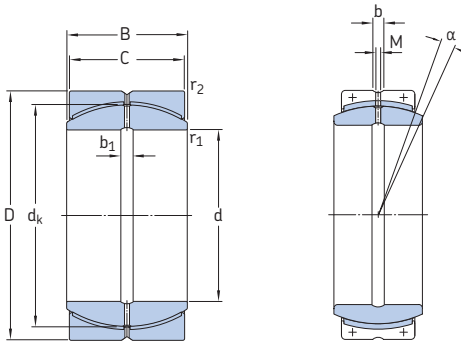

GEP..FS

GEC..FBAS

Principal dimensions				Angle of tilt	Basic load ratings		Mass	Designation
d	D	B	C	α	C	C_0		
mm				degrees	kN		kg	–
440	600	218	185	3	5 850	8 800	176	GEC 440 FBAS
	630	315	300	2	12 200	18 600	360	GEP 440 FS
460	620	218	185	3	6 000	9 000	182	GEC 460 FBAS
	650	325	308	2	12 900	19 600	380	GEP 460 FS
480	650	230	195	3	6 700	10 000	216	GEC 480 FBAS
	680	340	320	2	14 300	21 200	435	GEP 480 FS
500	670	230	195	3	6 800	10 200	224	GEC 500 FBAS
	710	355	335	2	15 300	23 200	500	GEP 500 FS
530	710	243	205	3	7 650	11 400	266	GEC 530 FBAS
	750	375	355	2	17 000	25 500	585	GEP 530 FS
560	750	258	215	4	8 500	12 700	313	GEC 560 FBAS
	800	400	380	2	19 600	29 000	730	GEP 560 FS
600	800	272	230	3	9 800	14 600	378	GEC 600 FBAS
	850	425	400	2	22 000	33 500	860	GEP 600 FS
630	850	300	260	3	11 800	18 000	494	GEC 630 FBAS
	900	450	425	2	24 500	37 500	1 040	GEP 630 FS
670	900	308	260	3	12 500	18 600	551	GEC 670 FBAS
	950	475	450	2	27 500	41 500	1 210	GEP 670 FS
710	950	325	275	3	14 000	21 200	643	GEC 710 FBAS
	1 000	500	475	2	31 000	46 500	1 400	GEP 710 FS
750	1 000	335	280	3	15 000	22 400	727	GEC 750 FBAS
	1 060	530	500	2	34 500	52 000	1 670	GEP 750 FS
800	1 060	355	300	3	17 300	26 000	861	GEC 800 FBAS
	1 120	565	530	2	39 000	58 500	1 940	GEP 800 FS
850	1 120	365	310	3	18 600	28 000	983	GEC 850 FBAS
	1 220	600	565	2	45 000	67 000	2 600	GEP 850 FS

Maintenance-free radial spherical plain bearings, steel/PTFE FRP, metric sizes
d 900 – 1 000 mm

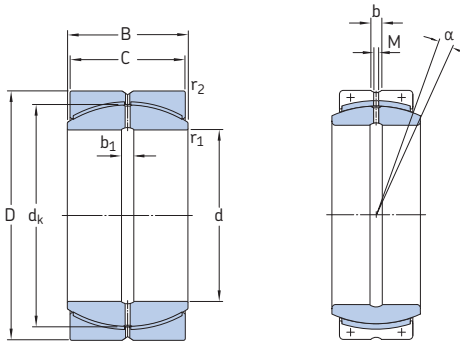

GEP..FS

GEC..FBAS

Principal dimensions				Angle of tilt	Basic load ratings		Mass	Designation
d	D	B	C	α	dynamic	static		
mm				degrees	kN		kg	–
900	1 180	375	320	3	20 400	31 000	1 120	GEC 900 FBAS
	1 250	635	600	2	49 000	73 500	2 690	GEP 900 FS
950	1 250	400	340	3	23 200	34 500	1 340	GEC 950 FBAS
	1 360	670	635	2	56 000	85 000	3 620	GEP 950 FS
1 000	1 320	438	370	3	27 000	40 000	1 650	GEC 1000 FBAS
	1 450	710	670	2	63 000	95 000	4 470	GEP 1000 FS

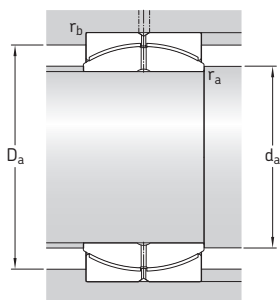

Dimensions							Abutment and fillet dimensions					
d	d _k	b	b ₁	M	r ₁ min	r ₂ min	d _a min	d _a max	D _a min	D _a max	r _a max	r _b max
mm							mm					
900	1 040	35	35	13	3	6	917	970	1 017	1 153	3	6
	1 142	35	35	13	3	7,5	938	949	1 063	1 183	3	7,5
950	1 100	40	40	15	4	7,5	969	1 024	1 074	1 217	4	7,5
	1 242	40	40	15	4	7,5	993	1 045	1 156	1 290	4	7,5
1 000	1 160	40	40	15	4	7,5	1 020	1 074	1 128	1 287	4	7,5
	1 312	40	40	15	4	7,5	1 045	1 103	1 221	1 378	4	7,5



Angular contact spherical plain bearings

Dimensions	152
Tolerances	152
Radial internal clearance, preload	153
Materials	154
Permissible operating temperature range	154
Special designs	154
Product tables	156
4.1 Maintenance-free angular contact spherical plain bearings, steel/PTFE FRP	156



Angular contact spherical plain bearings

As their name implies, the sliding contact surfaces of angular contact spherical plain bearings are spherical in shape and inclined at an angle to the bearing axis (→ **fig. 1**). Consequently, these bearings are well suited for accommodating combined (radial and axial) loads. Single angular contact spherical plain bearings can only accommodate axial loads acting in one direction. These bearings can be separated, enabling the rings to be mounted separately.

SKF manufactures steel/PTFE FRP (fibre reinforced polymer containing PTFE) maintenance-free angular contact spherical plain bearings as standard. Designs with other sliding surface combinations are available on request (→ *Special designs*, starting on **page 154**).

Dimensions

The boundary dimensions of SKF angular contact spherical plain bearings are in accordance with ISO 12240-2:1998.

Tolerances

The dimensional tolerances for SKF angular contact spherical plain bearings are listed in **table 1** and are in accordance with ISO 12240-2:1998.

The symbols used in the tolerance table are explained in the following:

d	nominal bore diameter
Δ_{dmp}	deviation of the mean bore diameter from the nominal
D	nominal outside diameter
Δ_{Dmp}	deviation of the mean outside diameter from the nominal
Δ_{Bs}	deviation of the single inner ring width from the nominal
Δ_{Cs}	deviation of the single outer ring width from the nominal
Δ_{Ts}	deviation of the single bearing width from the nominal

Table 1

Dimensional tolerances for angular contact spherical plain bearings

Nominal diameter d, D		Inner ring Δ_{dmp}				Outer ring Δ_{Dmp}				Bearing width $\Delta_{Ts}^{1)}$	
over	incl.	high	low	high	low	high	low	high	low	high	low
mm		μm									
18	50	0	-12	0	-240	0	-14	0	-240	+250	-400
50	80	0	-15	0	-300	0	-16	0	-300	+250	-500
80	120	0	-20	0	-400	0	-18	0	-400	+250	-600
120	150	-	-	-	-	0	-20	0	-500	-	-
150	180	-	-	-	-	0	-25	0	-500	-	-

¹⁾The tolerance of the bearing width depends on d .

Radial internal clearance, preload

The internal clearance of a single angular contact spherical plain bearing is only obtained after mounting and depends on the adjustment against a second bearing that provides axial location in the opposite direction. Angular contact spherical plain bearings are generally mounted as pairs in a back-to-back (→ **fig. 2**) or face-to-face arrangement (→ **fig. 3**). The bearings are adjusted against each other by axially displacing one bearing until a specific bearing load of 10 N/mm^2 is obtained. The preload prevents some of the deformations that typically occur under load and after a brief running-in period. When adjusting a new bearing arrangement for the first time, the specific bearing load of 10 N/mm^2 is achieved when the frictional moment and the axial preload force are in the ranges listed in **table 2**.

Table 2

Frictional moment and axial preload force

Bearing	Frictional moment for 10 N/mm^2		Axial preload force for 10 N/mm^2
	min	max	
–	Nm		N
GAC 25 F	7	9	5 600
GAC 30 F	12	14	7 500
GAC 35 F	16	19	9 300
GAC 40 F	21	25	10 600
GAC 45 F	26	32	13 600
GAC 50 F	31	38	12 900
GAC 60 F	51	62	17 800
GAC 70 F	76	92	21 000
GAC 80 F	105	126	30 000
GAC 90 F	153	184	41 700
GAC 100 F	180	216	39 500
GAC 110 F	273	328	54 500
GAC 120 F	317	380	69 500

Fig. 1

Load line through an angular contact spherical plain bearing

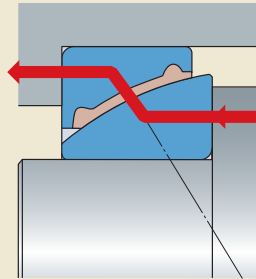

Fig. 2

Angular contact spherical plain bearings, back-to-back arrangement

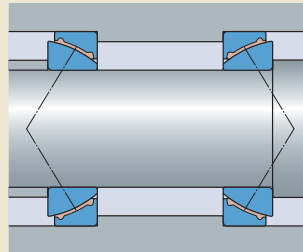
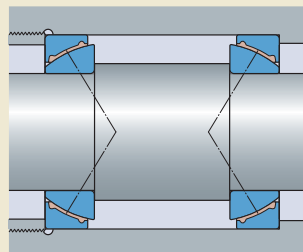

Fig. 3

Angular contact spherical plain bearings, face-to-face arrangement



Angular contact spherical plain bearings

Materials

The inner and outer rings of SKF angular contact spherical plain bearings are made of bearing steel that has been through-hardened and ground. The sliding layer of fibre reinforced polymer, containing PTFE, is injection moulded onto the outer ring (→ fig. 4). The sliding surface of the inner ring is hard chromium plated and coated with a lithium base grease.

Permissible operating temperature range

Spherical plain bearings with a steel/PTFE FRP sliding contact surface combination can be used for operating temperatures ranging from -40 to $+75$ °C. For brief periods, temperatures up to 110 °C can be tolerated. However, keep in mind that the load carrying capacity of the bearing is reduced at temperatures that exceed 50 °C. For additional information, contact the SKF application engineering service.

Special designs

Special operating conditions may require angular contact spherical plain bearings with a steel/PTFE fabric or steel/steel sliding contact surface combination. These bearings are available on request.

Bearings with a maintenance-free steel/PTFE fabric sliding contact surface combination (→ fig. 5) should be used when lubricant-free operation is specified. These bearings can accommodate heavy loads, preferably in a constant direction.

Steel/steel bearings (→ fig. 6) are typically used in applications where operating temperatures or load frequencies are high, or where heavy or shock loads occur. To operate properly, steel/steel bearings must be provided with an adequate supply of lubricant. Depending on the operating conditions, the sliding surface of the outer ring may be equipped with various multi-groove patterns (→ figs. 7 and 8). For additional information, contact the SKF application engineering service.

Upon request, inch steel/steel angular contact spherical plain bearings are also available as double direction angular contact spherical plain bearings. Double direction bearings can be used instead of two angular contact bearings in a face-to-face arrangement, or as a high capacity

Fig. 4

Maintenance-free angular contact spherical plain bearing, steel/PTFE FRP

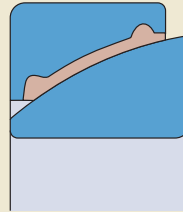

Fig. 5

Maintenance-free angular spherical plain bearing, steel/PTFE fabric

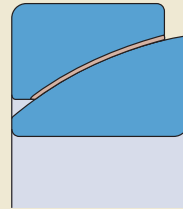

Fig. 6

Angular contact spherical plain bearing, steel/steel, requiring maintenance

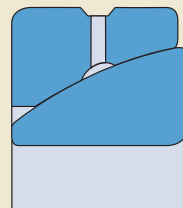

Fig. 7

Angular contact spherical plain bearing with "waffle" grooves, steel/steel

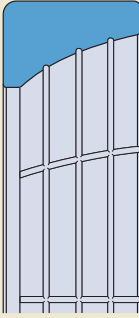

Fig. 8

Angular contact spherical plain bearing with "diamond thread" grooves, steel/steel

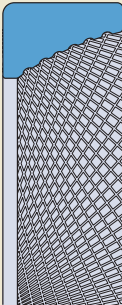
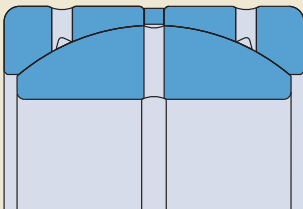

Fig. 9

Double direction angular contact spherical plain bearing in the GEZPR .. S series, steel/steel



radial bearing. Double direction angular contact spherical plain bearings consist of two outer rings and a standard inner ring. SKF supplies these bearings with (GEZPR .. S series) or without (GEZP .. S series) a shim between the two outer rings. The shim simplifies installation and optimizes axial internal clearance within the bearing (→ fig. 9).

Maintenance-free angular contact spherical plain bearings, steel/PTFE FRP
d 25 – 120 mm

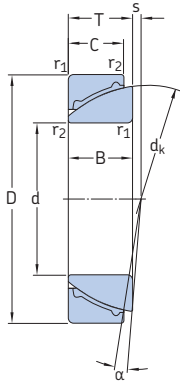

GAC..F

Principal dimensions			Angle of tilt α	Basic load ratings		Mass	Designation
d	D	T		dynamic	static		
mm			degrees	kN		kg	–
25	47	15	3,5	21,6	34,5	0,14	GAC 25 F
30	55	17	3,5	27	43	0,21	GAC 30 F
35	62	18	3,5	32,5	52	0,27	GAC 35 F
40	68	19	3,5	39	62	0,33	GAC 40 F
45	75	20	3	45,5	73,5	0,42	GAC 45 F
50	80	20	3	53	85	0,46	GAC 50 F
60	95	23	3	69,5	112	0,73	GAC 60 F
70	110	25	2,5	88	143	1,05	GAC 70 F
80	125	29	2,5	110	176	1,55	GAC 80 F
90	140	32	2,5	134	216	2,10	GAC 90 F
100	150	32	2	170	270	2,35	GAC 100 F
110	170	38	2	200	320	3,70	GAC 110 F
120	180	38	1,5	240	380	4,00	GAC 120 F

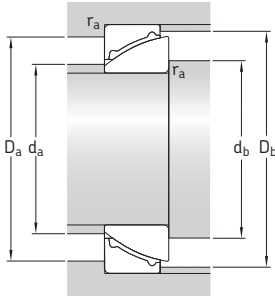

Dimensions

Abutment and fillet dimensions

d	d _k	B	C	r ₁ min	r ₂ min	s	d _a max	d _b max	D _a min	D _b min	r _a max
mm							mm				
25	42	15	14	0,6	0,3	0,6	29	39	34	43	0,6
30	49,5	17	15	1	0,3	1,3	35	45	39	50,5	1
35	55,5	18	16	1	0,3	2,1	40	50	45	56,5	1
40	62	19	17	1	0,3	2,8	45	54	50	63	1
45	68,5	20	18	1	0,3	3,5	51	60	55	69	1
50	74	20	19	1	0,3	4,3	56	67	60	74,5	1
60	88,5	23	21	1,5	0,6	5,7	68	77	70	90	1,5
70	102	25	23	1,5	0,6	7,2	78	92	85	103	1,5
80	115	29	25,5	1,5	0,6	8,6	88	104	95	116	1,5
90	128,5	32	28	2	0,6	10,1	101	118	105	129	2
100	141	32	31	2	0,6	11,6	112	128	120	141	2
110	155	38	34	2,5	0,6	13	124	145	130	156	2,5
120	168	38	37	2,5	0,6	14,5	134	155	140	169	2,5



Thrust spherical plain bearings

Dimensions	160
Tolerances	160
Materials	161
Permissible operating temperature range	161
Special designs	162
Product tables	164
5.1 Maintenance-free thrust spherical plain bearings, steel/PTFE FRP	164

Thrust spherical plain bearings

Thrust spherical plain bearings have a convex spherical surface on the shaft washer and a corresponding concave spherical surface in the housing washer (→ **fig. 1**). They are intended to accommodate primarily axial loads but can also accommodate combined (radial and axial) loads. The radial load component of a combined load should not exceed 50% of the axial load component. When radial loads are larger, it is advisable to combine thrust bearings with radial bearings in the GE dimension series (→ **fig. 2**). Thrust spherical plain bearings are separable, e.g. shaft and housing washers can be mounted separately.

SKF manufactures thrust spherical plain bearings with the maintenance-free steel/PTFE FRP (fibre reinforced polymer containing PTFE) sliding contact surface combination as standard. Other sliding surface combinations are available on request (→ *Special designs*, **page 162**).

Dimensions

The principal dimensions of SKF thrust spherical plain bearings are in accordance with ISO 12240-3:1998.

Tolerances

The dimensional tolerances for SKF thrust spherical plain bearings are listed in **table 1** and are in accordance with ISO 12240-3:1998.

The symbols used in the tolerance table are explained in the following:

d	nominal bore diameter (shaft washer)
Δ_{dmp}	deviation of the mean bore diameter from the nominal
D	nominal outside diameter (housing washer)
Δ_{Dmp}	deviation of the mean outside diameter from the nominal
Δ_{Bs}	deviation of the single shaft washer height from the nominal
Δ_{Cs}	deviation of the single housing washer height from the nominal
Δ_{Ts}	deviation of the single thrust bearing height from the nominal

Fig. 1

Standard thrust spherical plain bearing, steel/PTFE FRP

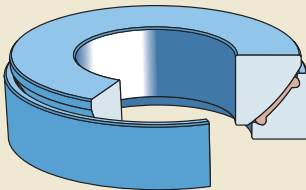
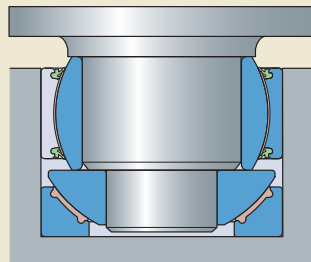

Fig. 2

Combination of a radial and a thrust spherical plain bearing



Materials

Shaft and housing washers for SKF thrust spherical plain bearings are made of bearing steel that has been through-hardened and ground. The sliding surface of the shaft washer is hard chromium plated and coated with a lithium base grease. The sliding layer of fibre reinforced polymer, containing PTFE, is injection moulded onto the housing washer.

Permissible operating temperature range

Thrust spherical plain bearings with a steel/PTFE FRP sliding contact surface combination can be used for operating temperatures ranging from -40 to $+75$ °C. For brief periods, temperatures up to 110 °C can be tolerated. However, keep in mind that the load carrying capacity of the bearing is reduced at temperatures that exceed 50 °C. For additional information, contact the SKF application engineering service.

Table 1

Dimensional tolerances for thrust spherical plain bearings

Nominal diameter d, D		Shaft washer				Housing washer				Bearing height	
over	incl.	Δ_{dmp}		Δ_{Bs}		Δ_{Dmp}		Δ_{Cs}		$\Delta_{Ts}^{1)}$	
		high	low	high	low	high	low	high	low	high	low
mm		μm				μm				μm	
–	18	0	–8	0	–240	–	–	–	–	+250	–400
18	30	0	–10	0	–240	–	–	–	–	+250	–400
30	50	0	–12	0	–240	0	–11	0	–240	+250	–400
50	80	0	–15	0	–300	0	–13	0	–300	+250	–500
80	120	0	–20	0	–400	0	–15	0	–400	+250	–600
120	150	–	–	–	–	0	–18	0	–500	–	–
150	180	–	–	–	–	0	–25	0	–500	–	–
180	230	–	–	–	–	0	–30	0	–600	–	–

¹⁾ The tolerance of the bearing height is dependent on d.

Special designs

Special operating conditions may require thrust spherical plain bearings with a steel/steel or steel/PTFE fabric sliding contact combination, which are available on request.

Steel/steel bearings (→ **fig. 3**) are typically used in applications where operating temperatures or load frequencies are high, or where heavy loads or shock loads occur. Steel/steel bearings must be provided with an adequate supply of lubricant. Depending on the operating conditions, the sliding surface of the outer ring may be equipped with various multi-groove patterns.

Bearings with a maintenance-free steel/PTFE fabric sliding contact surface (→ **fig. 4**) should be used when lubricant-free operation is specified. These bearings can accommodate heavy loads, preferably in a constant direction.

Fig. 3

Thrust spherical plain bearing, steel/steel, requiring maintenance

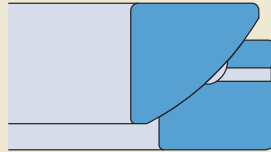
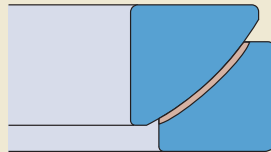
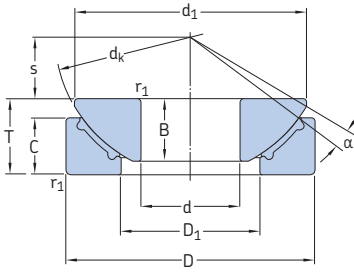

Fig. 4

Maintenance-free thrust spherical plain bearing, steel/PTFE fabric



Maintenance-free thrust spherical plain bearings, steel/PTFE FRP
d 17 – 120 mm



GX..F

Principal dimensions			Angle of tilt	Basic load ratings		Mass	Designation
d	D	T	α	dynamic	static		
mm			degrees	kN		kg	–
17	47	16	5	36,5	58,5	0,14	GX 17 F
20	55	20	5	46,5	73,5	0,25	GX 20 F
25	62	22,5	5	69,5	112	0,42	GX 25 F
30	75	26	5	95	153	0,61	GX 30 F
35	90	28	6	134	216	0,98	GX 35 F
40	105	32	6	173	275	1,50	GX 40 F
45	120	36,5	6	224	355	2,25	GX 45 F
50	130	42,5	6	275	440	3,15	GX 50 F
60	150	45	6	375	600	4,65	GX 60 F
70	160	50	5	475	750	5,40	GX 70 F
80	180	50	5	570	915	6,95	GX 80 F
100	210	59	5	735	1 180	11,0	GX 100 F
120	230	64	4	880	1 430	14,0	GX 120 F

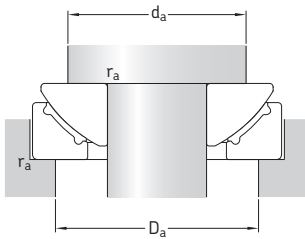

Dimensions

Abutment and fillet dimensions

d	d_k	d_1	D_1	B	C	$r_{1 \text{ min}}$	s	$d_a \text{ min}$	$D_a \text{ max}$	$r_a \text{ max}$
mm								mm		
17	52	43,5	27	11,8	11,2	0,6	11	34	37	0,6
20	60	50	31	14,5	13,8	1	12,5	40	44	1
25	68	58,5	34,5	16,5	16,7	1	14	45	47	1
30	82	70	42	19	19	1	17,5	56	59	1
35	98	84	50,5	22	20,7	1	22	66	71	1
40	114	97	59	27	21,5	1	24,5	78	84	1
45	128	110	67	31	25,5	1	27,5	89	97	1
50	139	120	70	33	30,5	1	30	98	105	1
60	160	140	84	37	34	1	35	109	120	1
70	176	153	94,5	42	36,5	1	35	121	125	1
80	197	172	107,5	43,5	38	1	42,5	135	145	1
100	222	198	127	51	46	1	45	155	170	1
120	250	220	145	53,5	50	1	52,5	170	190	1



Rod ends requiring maintenance

Dimensions	168
Tolerances	168
Radial internal clearance	169
Materials	169
Permissible operating temperature range	170
Fatigue strength	171
Relubrication facilities	171
Product tables	172
6.1 Rod ends with a female thread, steel/steel	172
6.2 Rod ends with a female thread, for hydraulic cylinders, steel/steel	174
6.3 Rod ends with a male thread, steel/steel	178
6.4 Rod ends with a cylindrical section welding shank, steel/steel	180
6.5 Rod ends with a rectangular section welding shank, steel/steel	182
6.6 Rod ends with a female thread, steel/bronze	184
6.7 Rod ends with a male thread, steel/bronze	186

Rod ends requiring maintenance

SKF manufactures rod ends requiring maintenance with a steel/steel or a steel/bronze sliding contact surface combination.

Steel/steel rod ends consist of a rod end housing and a steel/steel radial spherical plain bearing from the standard assortment, where the outer ring is secured in the housing. These rod ends are available with a female thread (→ **fig. 1**), male thread (→ **fig. 2**) or a welding shank (→ **fig. 3**).

Steel/bronze rod ends consist of a rod end housing and a steel/bronze spherical plain bearing. These bearings have an inner ring made of steel and an outer ring made of bronze. The bearing is held in position by staking the housing on both sides of the outer ring. These rod ends are available with a male or female thread.

SKF supplies rod ends with a threaded shank with a right-hand thread as standard. With the exception of rod ends with the designation suffix VZ019, all rod ends are also available with a left-hand thread. They are identified by the designation prefix L.

Dimensions

The dimensions of SKF rod ends requiring maintenance are in accordance with the standards listed in **table 1**.

Male and female threads of SKF rod ends are in accordance with ISO 965-1:1998, except for rod ends with female thread having the designation suffix /VZ019, which is in accordance with ISO 8139:2009.

Tolerances

SKF rod end inner ring dimensional tolerances are in accordance with ISO 12240-4:1998. The tolerances for the steel/steel rod end inner rings are listed in **table 3** and the tolerances for steel/bronze rod end inner rings are listed in **table 2**.

The symbols used in these tables are explained in the following:

- d nominal bore diameter
- Δ_{dmp} deviation of the mean bore diameter from the nominal
- Δ_{Bs} deviation of the single inner ring width from the nominal

Fig. 1

Rod end with a female thread

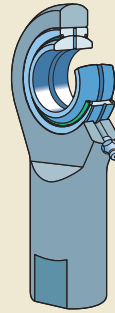

Fig. 2

Rod end with a male thread

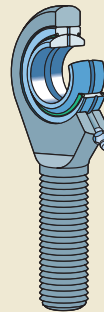
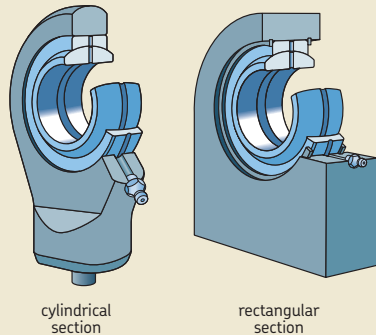

Fig. 3

Rod ends with a welding shank



Radial internal clearance

The clearance values for steel/steel rod ends are in accordance with dimension series E and EH of ISO 12240-4:1998, as far as they have been standardized. The values are listed in **table 4** on **page 170**.

The clearance values for steel/bronze rod ends are in accordance with dimensions series K of ISO 12240-4:1998 and are listed in **table 5** on **page 170**.

Materials

SKF rod end housings for bearings that require maintenance are made of the materials listed in **table 6** on **page 170**.

The materials used for steel/steel radial spherical plain bearings incorporated in SKF rod ends are provided in the section *Materials* on **page 102**.

The bearings incorporated in the steel/bronze rod ends have an outer ring made of bronze and an inner ring made of bearing steel which has been hardened and ground.

Table 1

Standards	
Series	Standards
SA(A) SI(A)	ISO 12240-4:1998 dimension series E, EH ISO 12240-4:1998 dimension series E, EH
SC SCF	ISO 12240-4:1998 dimension series E –
SIJ SIR SIQG	ISO 8133:2006 – ISO 8132:2006
SAKAC SIKAC SIKAC/VZ019	ISO 12240-4:1998 dimension series K ISO 12240-4:1998 dimension series K ISO 8139:2009, ISO 12240-4:1998

Table 2

Inner ring dimensional tolerances for steel/bronze rod ends

Bore diameter d over incl.		SIKAC and SAKAC series			
		Δ_{dmp} high	low	Δ_{Bs} high	low
mm		μm		μm	
–	6	12	0	0	–120
6	10	15	0	0	–120
10	18	18	0	0	–120
18	30	21	0	0	–120

Table 3

Inner ring dimensional tolerances for steel/steel rod ends

Bore diameter d over incl.		SA(A), SI(A), SIJ, SIR, SC and SCF series				SIQG series			
		Δ_{dmp} high	low	Δ_{Bs} high	low	Δ_{dmp} high	low	Δ_{Bs} high	low
mm		μm		μm		μm		μm	
–	10	0	–8	0	–120	–	–	–	–
10	18	0	–8	0	–120	18	0	0	–180
18	30	0	–10	0	–120	21	0	0	–210
30	50	0	–12	0	–120	25	0	0	–250
50	80	0	–15	0	–150	30	0	0	–300
80	120	0	–20	0	–200	35	0	0	–350
120	180	0	–25	0	–250	40	0	0	–400
180	250	0	–30	0	–300	46	0	0	–460

Rod ends requiring maintenance

Permissible operating temperature range

The permissible operating temperature range for SKF rod ends requiring maintenance depends on the rod end housing, the bearing, the bearing seals and the grease used for lubrication. The values for the permissible operating temperature range are listed in **table 7**.

The load carrying capacity of the rod end is reduced at temperatures above 100 °C. For temperatures below 0 °C, check to be sure that the fracture toughness of the rod end housing is adequate for the intended application.

Table 4

Radial internal clearance for steel/steel rod ends

Bore diameter d	over	incl.	Radial internal clearance	
			Normal	max
mm		µm		
–	12		16	68
12	20		20	82
20	35		25	100
35	60		30	120
60	90		36	142
90	140		42	165
140	240		50	192

Table 5

Radial internal clearance for steel/bronze rod ends

Bore diameter d	over	incl.	Radial internal clearance	
			Normal	max
mm		µm		
–	6		5	50
6	10		7	61
10	18		8	75
18	30		10	92

Table 6

Housing materials for rod ends requiring maintenance

Series	Size	Material	Material No.
SA(A)	6 to 80	Heat treatable steel C45V zinc coated and chromitized	1.0503
SI(A)	6 to 80	Heat treatable steel C45V zinc coated and chromitized	1.0503
SC	20 to 80	Construction steel S 355 J2G3 (St 52-3 N)	1.0570
SCF	20 to 80	Construction steel S 355 J2G3 (St 52-3 N)	1.0570
SIQG	12 to 63 70 to 200	Heat treatable steel C45 EN-GJS-400-15	1.0503 –
SIJ	12 to 50 60 to 100	Heat treatable steel C45 EN-GJS-400-15	1.0503 –
SIR	25 to 80 90 to 120	Heat treatable steel C45 EN-GJS-400-15	1.0503 –
SAKAC	5 to 12 14 to 30	Free-machining steel 9 SMnPb 28 K zinc coated and chromitized Heat treatable steel C35N	1.0718 1.0501
SIKAC	5 to 12 14 to 30	Free-machining steel 9 SMnPb 28 K zinc coated and chromitized Heat treatable steel C35N	1.0718 1.0501

SKF reserves the right to use similar material or material of higher strength.

Fatigue strength

In all applications where a rod end is subjected to alternating loads, loads that vary in magnitude or where failure of a rod end is dangerous, make sure that the selected rod end has sufficient fatigue strength.

Relubrication facilities

SKF rod ends requiring maintenance are provided with a grease fitting or a lubrication hole in the rod end housing. Relubrication via the pin is also possible. Exceptions are steel/steel rod ends in the SA .. E and SI .. E series and a few smaller rod ends as indicated in the product tables. The type and design of relubrication facilities in the rod end housing are listed in **table 8**.

Table 7



Permissible operating temperature range for rod ends requiring maintenance

Series	Permissible operating temperature range ¹⁾	
	from	incl.
–	°C	
Steel/steel rod ends		
SA .. E(S)	–50	+200
SA(A) .. ES(-2RS)	–30	+130
SI .. E(S)	–50	+200
SI(A) .. ES(-2RS)	–30	+130
SIQG .. ES	–50	+200
SIJ .. ES	–50	+200
SIR .. ES	–50	+200
SC(F) .. ES	–50	+200
Steel/bronze rod ends		
SAKAC .. M	–30	+180
SIKAC .. M (/VZ 019)	–30	+180

¹⁾ Permissible operating temperature range of the grease must be considered.

Table 8

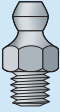
Relubrication facilities for rod ends requiring maintenance

Series	Size	Relubrication facilities Design	
Steel/steel rod ends			
SA .. ES	15 to 20	Lubrication hole diameter 2,5 mm	
SI .. ES	15 to 20		
SI .. ES	15 to 20		
SIJ .. ES	16 to 20		
SC .. ES	20		
SA(A) .. ES(-2RS)	25 to 80	Grease fitting in accordance with DIN 71412: 1987	
SI(A) .. ES(-2RS)	25 to 80		
SIJ .. ES	25 to 100		
SIR .. ES	25 to 120		
SIQG .. ES(A)	12 to 200		
SC .. ES	25 to 80		
SCF .. ES	20 to 80		
Steel/bronze rod ends			
SAKAC .. M	6 to 30	Grease fitting in accordance with DIN 3405: 1986	
SIKAC .. M (/VZ 019)	6 to 30		

Rod ends with a female thread, steel/steel
d 6 – 80 mm

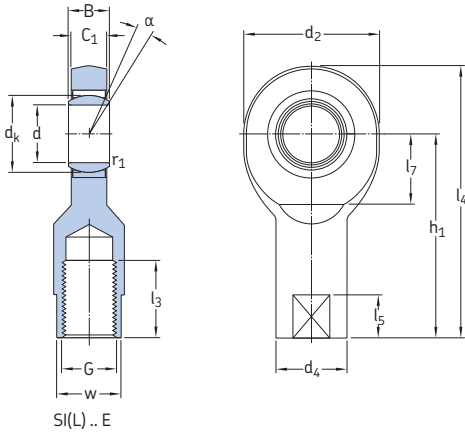

Principal dimensions				Angle of tilt α	Basic load ratings		Mass	Designations Rod end with right-hand thread	left-hand thread		
d	d ₂ max	G 6H	B		C ₁ max	h ₁				C	C ₀
mm						degrees	kN	kg	–		
6	22	M 6	6	4,5	30	13	3,4	8,15	0,023	SI 6 E ¹⁾	SIL 6 E ¹⁾
8	25	M 8	8	6,5	36	15	5,5	12,9	0,036	SI 8 E ¹⁾	SIL 8 E ¹⁾
10	30	M 10	9	7,5	43	12	8,15	19	0,065	SI 10 E ¹⁾	SIL 10 E ¹⁾
12	35	M 12	10	8,5	50	10	10,8	25,5	0,11	SI 12 E ¹⁾	SIL 12 E ¹⁾
15	41	M 14	12	10,5	61	8	17	37,5	0,18	SI 15 ES	SIL 15 ES
17	47	M 16	14	11,5	67	10	21,2	44	0,25	SI 17 ES	SIL 17 ES
20	54	M 20×1,5	16	13,5	77	9	30	57	0,36	SI 20 ES	SIL 20 ES
25	65	M 24×2	20	18	94	7	48	90	0,65	SI 25 ES	SIL 25 ES
30	75	M 30×2	22	20	110	6	62	116	1,00	SI 30 ES	SIL 30 ES
35	84	M 36×3	25	22	130	6	80	134	1,40	SI 35 ES-2RS	SIL 35 ES-2RS
40	94	M 39×3	28	24	142	6	100	166	2,20	SIA 40 ES-2RS	SILA 40 ES-2RS
	94	M 42×3	28	24	145	6	100	166	2,30	SI 40 ES-2RS	SIL 40 ES-2RS
45	104	M 42×3	32	28	145	7	127	224	2,90	SIA 45 ES-2RS	SILA 45 ES-2RS
	104	M 45×3	32	28	165	7	127	224	3,20	SI 45 ES-2RS	SIL 45 ES-2RS
50	114	M 45×3	35	31	160	6	156	270	4,10	SIA 50 ES-2RS	SILA 50 ES-2RS
	114	M 52×3	35	31	195	6	156	270	4,50	SI 50 ES-2RS	SIL 50 ES-2RS
60	137	M 52×3	44	39	175	6	245	400	6,30	SIA 60 ES-2RS	SILA 60 ES-2RS
	137	M 60×4	44	39	225	6	245	400	7,10	SI 60 ES-2RS	SIL 60 ES-2RS
70	162	M 56×4	49	43	200	6	315	530	9,50	SIA 70 ES-2RS	SILA 70 ES-2RS
	162	M 72×4	49	43	265	6	315	530	10,5	SI 70 ES-2RS	SIL 70 ES-2RS
80	182	M 64×4	55	48	230	5	400	655	15,0	SIA 80 ES-2RS	SILA 80 ES-2RS
	182	M 80×4	55	48	295	5	400	655	19,0	SI 80 ES-2RS	SIL 80 ES-2RS

¹⁾ No relubrication facilities.

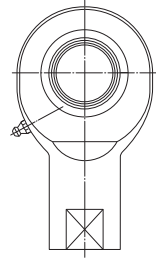
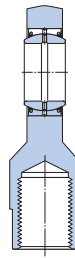
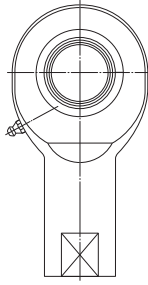
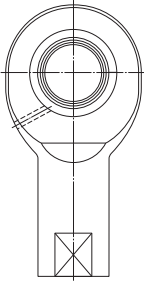
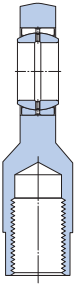

SI(L) .. ES

$d \leq 20 \text{ mm}$

$d \geq 25 \text{ mm}$

SI(L)A .. ES-2RS
SI(L) .. ES-2RS

Dimensions

d	d_k	d_4 ≈	l_3 min	l_4 max	l_5 ≈	l_7 min	r_1 min	w h14
6	10	11	11	43	8	10	0,3	9
8	13	13	15	50	9	11	0,3	11
10	16	16	15	60	11	13	0,3	14
12	18	19	18	69	12	17	0,3	17
15	22	22	21	83	14	19	0,3	19
17	25	25	24	92	15	22	0,3	22
20	29	28	30	106	16	24	0,3	24
25	35,5	35	36	128	18	30	0,6	30
30	40,7	42	45	149	19	34	0,6	36
35	47	49	60	174	25	40	0,6	41
40	53 53	58 58	65 65	191 194	25 25	46 46	0,6 0,6	50 50
45	60 60	65 65	65 65	199 219	30 30	50 50	0,6 0,6	55 55
50	66 66	70 70	68 68	219 254	30 30	58 58	0,6 0,6	60 60
60	80 80	82 82	70 70	246 296	35 35	73 73	1 1	70 70
70	92 92	92 92	80 80	284 349	40 40	85 85	1 1	80 80
80	105 105	105 105	85 85	324 389	45 45	98 98	1 1	90 90

Rod ends with a female thread, for hydraulic cylinders, steel/steel
d 12 – 70 mm

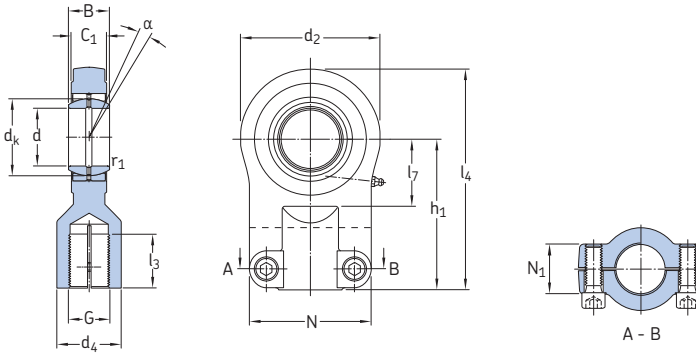

SI(LJ) .. ES

Principal dimensions					Angle of tilt	Basic load ratings		Mass	Designations		
d	d ₂ max	G 6H	B	C ₁ max	h ₁	α	C	C ₀	Rod end with right-hand thread	left-hand thread ¹⁾	
						degrees	kN		kg	-	
12	36	M 10×1,25	10	8	42	3	10,8	21,2	0,14	SIJ 12 E ²⁾	SILJ 12 E ²⁾
	33	M 12×1,25	12	11	38	4	10,8	22	0,11	SIQG 12 ESA ³⁾	SILQG 12 ESA ³⁾
16	45	M 12×1,25	14	11	48	3	21,2	23,5	0,25	SIJ 16 ES	SILJ 16 ES
	41	M 14×1,5	16	14	44	4	17,6	32,5	0,21	SIQG 16 ES	SILQG 16 ES
20	55	M 14×1,5	16	13	58	3	30	51	0,40	SIJ 20 ES	SILJ 20 ES
	48	M 16×1,5	20	17,5	52	4	30	43	0,40	SIQG 20 ES	SILQG 20 ES
25	65	M 16×1,5	20	17	68	3	48	73,5	0,68	SIJ 25 ES	SILJ 25 ES
	57	M 16×1,5	20	23,5	50	7	48	52	0,49	SIR 25 ES	SILR 25 ES
	59	M 20×1,5	25	22	65	4	48	69,5	0,66	SIQG 25 ES	SILQG 25 ES
30	80	M 20×1,5	22	19	85	3	62	112	1,35	SIJ 30 ES	SILJ 30 ES
	65	M 22×1,5	22	28,5	60	6	62	78	0,77	SIR 30 ES	SILR 30 ES
32	71	M 27×2	32	28	80	4	65,5	100	1,20	SIQG 32 ES	SILQG 32 ES
35	79	M 28×1,5	25	30,5	70	6	80	118	1,20	SIR 35 ES	SILR 35 ES
40	98	M 27×2	28	23	105	3	100	146	2,40	SIJ 40 ES	SILJ 40 ES
	95	M 35×1,5	28	35,5	85	7	100	200	2,10	SIR 40 ES	SILR 40 ES
	90	M 33×2	40	34	97	4	100	176	2,00	SIQG 40 ES	SILQG 40 ES
50	122	M 33×2	35	30	130	3	156	216	3,80	SIJ 50 ES	SILJ 50 ES
	118	M 45×1,5	35	40,5	105	6	156	280	3,60	SIR 50 ES	SILR 50 ES
	110	M 42×2	50	42	120	4	156	270	3,50	SIQG 50 ES	SILQG 50 ES
60	160	M 42×2	44	38	150	3	245	405	8,50	SIJ 60 ES	SILJ 60 ES
	132	M 58×1,5	44	50,5	130	6	245	325	6,00	SIR 60 ES	SILR 60 ES
63	134	M 48×2	63	53,5	140	4	255	375	6,80	SIQG 63 ES	SILQG 63 ES
70	156	M 65×1,5	49	55,5	150	6	315	450	9,40	SIR 70 ES	SILR 70 ES

¹⁾ Check availability of rod ends with left-hand thread.

²⁾ No relubrication facilities.

³⁾ Can only be relubricated via the outer ring.

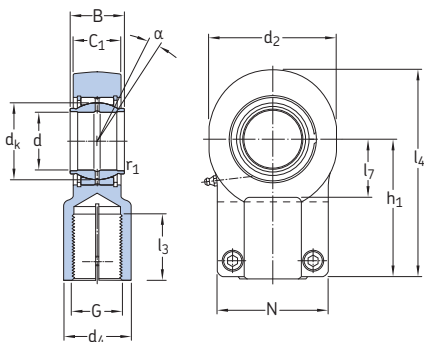

SI(L)QG..ES

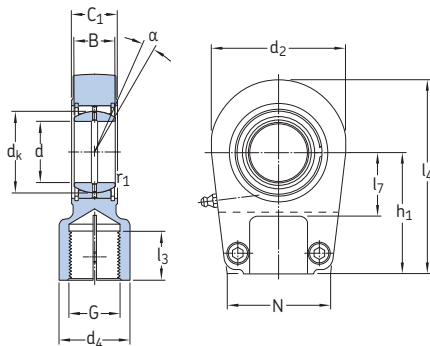

SI(L)R..ES

Dimensions

**Cylinder bolt
with internal hexagon
(ISO 4762:1998)**

d	dk	d ₄ max	l ₃ min	l ₄ max	l ₇ min	N max	N ₁ max	r ₁ min	Size	Tightening torque
mm									–	Nm
12	18	17	15	62	16	40	13	0,3	M 6	10
	18	17	17	55	13	33	11	0,3	M 5	5,5
16	25	21	17	70,5	20	45	13	0,3	M 6	10
	23	22	19	64,5	17	41	14	0,3	M 6	9,5
20	29	25	19	85,5	25	55	17	0,3	M 8	25
	29	26,5	23	77	21	48	18	0,3	M 8	23
25	35,5	30	23	100,5	30	62	17	0,6	M 8	25
	35,5	26	17	79,5	27	42	23,5	0,6	M 8	23
	35,5	31	29	97	26	55	18	0,6	M 8	23
30	40,7	36	29	125	35	80	19	0,6	M 10	45
	40,7	33	23	93,5	29	47	28,5	0,6	M 8	23
32	43	38	37	116,5	31	67	23	0,6	M 10	46
35	47	41,5	29	110,5	37	59	30,5	0,6	M 10	46
40	53	45	37	155	45	90	23	0,6	M 10	45
	53	50,5	36	133,5	44	67	35,5	0,6	M 10	46
	53	47	46	143	40	81	28	0,6	M 10	46
50	66	55	46	192,5	58	105	30	0,6	M 12	80
	66	62,5	46	164,5	54	89	40,5	0,6	M 12 ¹⁾	79 ¹⁾
	66	58	57	175,5	49	97,5	33	0,6	M 12	79
60	80	68	57	230	68	134	38	1	M 16	160
	80	76,5	59	202,5	64	91	50,5	1	M 16 ¹⁾	46 ¹⁾
63	83	70	64	213,5	61	116	40	1	M 16 ¹⁾	195 ¹⁾
70	92	87,5	66	234,5	74	101	55,5	1	M 16 ¹⁾	79 ¹⁾

¹⁾ Bolts, position of bolts, and tightening torque may vary.

Rod ends with a female thread, for hydraulic cylinders, steel/steel
d 80 – 200 mm

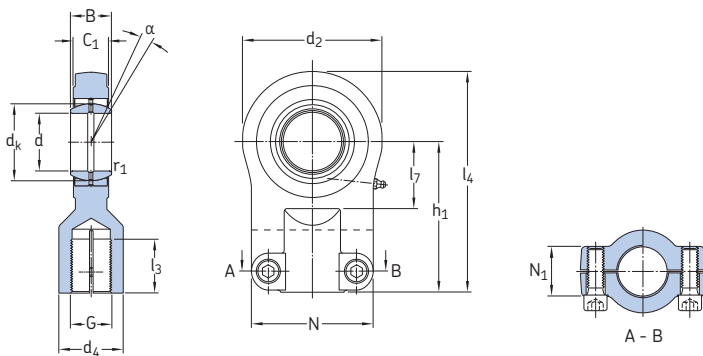

SI(L)J .. ES

Principal dimensions						Angle of tilt	Basic load ratings		Mass	Designations	
d	d ₂ max	G 6H	B	C ₁ max	h ₁	α	C	C ₀		Rod end with right-hand thread	left-hand thread
mm						degrees	kN		kg	–	
80	205	M 48×2	55	47	185	3	400	610	14,5	SIJ 80 ES	SILJ 80 ES
	178	M 80×2	55	60,5	170	6	400	560	13,0	SIR 80 ES	SILR 80 ES
	170	M 64×3	80	68	180	4	400	600	14,5	SIQG 80 ES	SILQG 80 ES
100	240	M 64×3	70	57	240	3	610	780	29,5	SIJ 100 ES	SILJ 100 ES
	232	M 110×2	70	70,5	235	7	610	950	30,0	SIR 100 ES	SILR 100 ES
	212	M 80×3	100	85,5	210	4	610	930	28,0	SIQG 100 ES	SILQG 100 ES
120	343	M 130×3	85	90,5	310	6	950	2 450	84,0	SIR 120 ES	SILR 120 ES
125	268	M 100×3	125	105	260	4	950	1 430	43,0	SIQG 125 ES	SILQG 125 ES
160	328	M 125×4	160	133	310	4	1 370	2 200	80,0	SIQG 160 ES	SILQG 160 ES
200	420	M 160×4	200	165	390	4	2 120	3 400	165	SIQG 200 ES	SILQG 200 ES

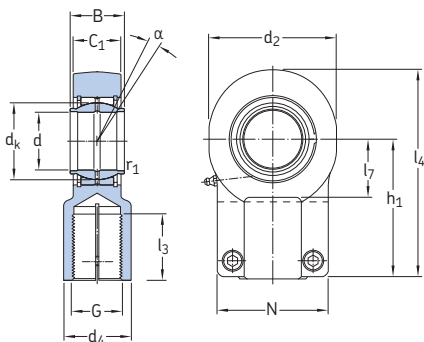

SI(L)QG..ES

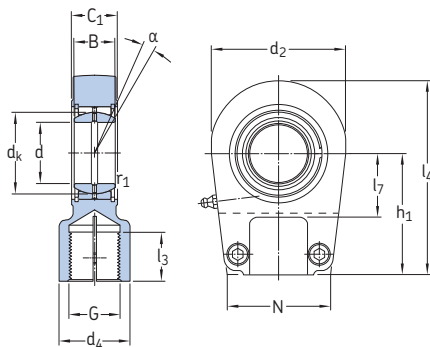

SI(L)R..ES

Dimensions

d	d _k	d ₄ max	l ₃ min	l ₄ max	l ₇ min	N max	N ₁ max	r ₁ min	Cylinder bolt with internal hexagon (ISO 4762:1998)	
									Size	Tightening torque
mm									-	Nm
80	105	90	64	287,5	92	156	47	1	M 20	310
	105	103,5	81	267,5	79	126	60,5	1	M 20 ¹⁾	195 ¹⁾
	105	91	86	272,5	77	150	50	1	M 20 ¹⁾	390 ¹⁾
100	130	110	86	360	116	190	57	1	M 24	530
	130	140	111	362,5	103	167	70,5	1	M 24 ¹⁾	390 ¹⁾
	130	110	96	324	97	180	65	1	M 24 ¹⁾	670 ¹⁾
120	160	175	135	493	138	257	86	1	M 24 ¹⁾	670 ¹⁾
125	160	135	113	407	118	202	75	1	M 24 ¹⁾	670 ¹⁾
160	200	165	126	490	148	252	85	1	M 24 ¹⁾	670 ¹⁾
200	250	215	161	623	193	323	106	1,1	M 30 ¹⁾	1 350 ¹⁾

¹⁾ Bolts, position of bolts, and tightening torque may vary.

Rod ends with a male thread, steel/steel
d 6 – 80 mm

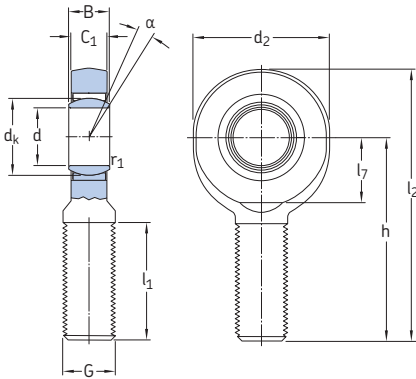

SA(L) .. E

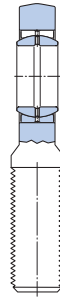

SA(L) .. ES

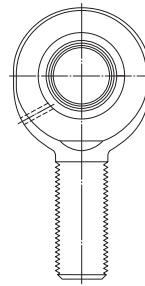

$d \leq 20 \text{ mm}$

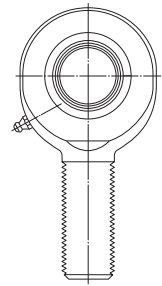

$d \geq 25 \text{ mm}$

Principal dimensions						Angle of tilt	Basic load ratings		Mass	Designations	
d	d ₂ max	G 6g	B	C ₁ max	h	α	C	C ₀		Rod end with right-hand thread	left-hand thread
mm						degrees	kN		kg	-	
6	22	M 6	6	4,5	36	13	3,4	8,15	0,017	SA 6 E ¹⁾	SAL 6 E ¹⁾
8	25	M 8	8	6,5	42	15	5,5	12,9	0,029	SA 8 E ¹⁾	SAL 8 E ¹⁾
10	30	M 10	9	7,5	48	12	8,15	18,3	0,053	SA 10 E ¹⁾	SAL 10 E ¹⁾
12	35	M 12	10	8,5	54	10	10,8	24,5	0,078	SA 12 E ¹⁾	SAL 12 E ¹⁾
15	41	M 14	12	10,5	63	8	17	28	0,13	SA 15 ES	SAL 15 ES
17	47	M 16	14	11,5	69	10	21,2	31	0,19	SA 17 ES	SAL 17 ES
20	54	M 20x1,5	16	13,5	78	9	30	42,5	0,32	SA 20 ES	SAL 20 ES
25	65	M 24x2	20	18	94	7	48	78	0,53	SA 25 ES	SAL 25 ES
30	75	M 30x2	22	20	110	6	62	81,5	0,90	SA 30 ES	SAL 30 ES
35	84	M 36x3	25	22	130	6	80	110	1,30	SA 35 ES-2RS	SAL 35 ES-2RS
40	94	M 39x3	28	24	150	6	100	140	1,85	SAA 40 ES-2RS	SALA 40 ES-2RS
	94	M 42x3	28	24	145	6	100	140	1,90	SA 40 ES-2RS	SAL 40 ES-2RS
45	104	M 42x3	32	28	163	7	127	200	2,45	SAA 45 ES-2RS	SALA 45 ES-2RS
	104	M 45x3	32	28	165	7	127	200	2,55	SA 45 ES-2RS	SAL 45 ES-2RS
50	114	M 45x3	35	31	185	6	156	245	3,30	SAA 50 ES-2RS	SALA 50 ES-2RS
	114	M 52x3	35	31	195	6	156	245	3,90	SA 50 ES-2RS	SAL 50 ES-2RS
60	137	M 52x3	44	39	210	6	245	360	5,70	SAA 60 ES-2RS	SALA 60 ES-2RS
	137	M 60x4	44	39	225	6	245	360	6,25	SA 60 ES-2RS	SAL 60 ES-2RS
70	162	M 56x4	49	43	235	6	315	490	7,90	SAA 70 ES-2RS	SALA 70 ES-2RS
	162	M 72x4	49	43	265	6	315	490	10,0	SA 70 ES-2RS	SAL 70 ES-2RS
80	182	M 64x4	55	48	270	5	400	585	12,0	SAA 80 ES-2RS	SALA 80 ES-2RS
	182	M 80x4	55	48	295	5	400	585	14,5	SA 80 ES-2RS	SAL 80 ES-2RS

¹⁾ No relubrication facilities.

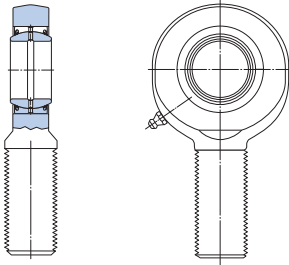

SA(L)A..ES-2RS

Dimensions

d	d _k	l ₁ min	l ₂ max	l ₇ min	r ₁ min
mm					
6	10	16	49	10	0,3
8	13	21	56	11	0,3
10	16	26	65	13	0,3
12	18	28	73	17	0,3
15	22	34	85	19	0,3
17	25	36	94	22	0,3
20	29	43	107	24	0,3
25	35,5	53	128	30	0,6
30	40,7	65	149	34	0,6
35	47	82	174	40	0,6
40	53	86	199	46	0,6
	53	90	194	46	0,6
45	60	92	217	50	0,6
	60	95	219	50	0,6
50	66	104	244	58	0,6
	66	110	254	58	0,6
60	80	115	281	73	1
	80	120	296	73	1
70	92	125	319	85	1
	92	132	349	85	1
80	105	140	364	98	1
	105	147	389	98	1

Rod ends with a cylindrical section welding shank, steel/steel
d 20 – 80 mm

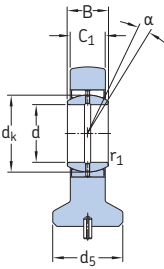

SC..ES

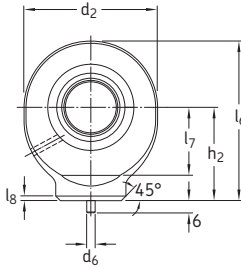

d = 20 mm

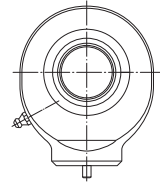

d ≥ 25 mm

Principal dimensions					Angle of tilt	Basic load ratings dynamic static		Mass	Designation
d	d _{2 max}	B	C _{1 max}	h ₂	α	C	C ₀		
mm					degrees	kN		kg	-
20	54	16	13,5	38	9	30	46,5	0,20	SC 20 ES
25	65	20	18	45	7	48	73,5	0,45	SC 25 ES
30	75	22	20	51	6	62	96,5	0,65	SC 30 ES
35	84	25	22	61	6	80	112	1,00	SC 35 ES
40	94	28	24	69	7	100	134	1,30	SC 40 ES
45	104	32	28	77	7	127	180	1,90	SC 45 ES
50	114	35	31	88	6	156	220	2,50	SC 50 ES
60	137	44	39	100	6	245	335	4,60	SC 60 ES
70	162	49	43	115	6	315	455	6,80	SC 70 ES
80	182	55	48	141	6	400	550	9,70	SC 80 ES

Dimensions

d	d _k	d ₅ max	d ₆	l ₆ max	l ₇ min	r ₁ min	l ₈
mm							
20	29	29	4	66	24	0,3	2
25	35,5	35	4	78	30	0,6	3
30	40,7	42	4	89	34	0,6	3
35	47	49	4	104	40	0,6	3
40	53	54	4	118	46	0,6	4
45	60	60	6	132	50	0,6	4
50	66	64	6	150	58	0,6	4
60	80	72	6	173	73	1	4
70	92	82	6	199	85	1	5
80	105	97	6	237	98	1	5

Rod ends with a rectangular section welding shank, steel/steel
d 20 – 80 mm

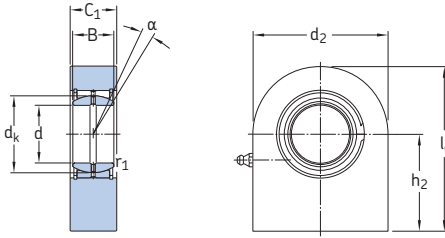

SCF .. ES

Principal dimensions					Angle of tilt	Basic load ratings		Mass	Designation
d	d _{2 max}	B	C _{1 max}	h _{2 js13}	α	C	C ₀		
mm					degrees	kN		kg	–
20	51,5	16	20	38	9	30	63	0,35	SCF 20 ES
25	56,5	20	24	45	7	48	65,5	0,53	SCF 25 ES
30	66,5	22	29	51	6	62	110	0,87	SCF 30 ES
35	85	25	31	61	6	80	183	1,55	SCF 35 ES
40	102	28	36,5	69	7	100	285	2,45	SCF 40 ES
45	112	32	41,5	77	7	127	360	3,40	SCF 45 ES
50	125,5	35	41,5	88	6	156	415	4,45	SCF 50 ES
60	142,5	44	51,5	100	6	245	530	7,00	SCF 60 ES
70	166,5	49	57	115	6	315	680	10,0	SCF 70 ES
80	182,5	55	62	141	6	400	750	15,0	SCF 80 ES
90	228,5	60	67	150	5	490	1 290	23,5	SCF 90 ES
100	252,5	70	72	170	7	610	1 430	31,5	SCF 100 ES
110	298	70	83	185	6	655	2 200	48,0	SCF 110 ES
120	363	85	92,5	210	6	950	3 250	79,5	SCF 120 ES

Dimensions

d	d _k	l ₆ max	r ₁ min
mm			
20	29	64	0,3
25	35,5	73,5	0,6
30	40,7	85	0,6
35	47	103,5	0,6
40	53	120	0,6
45	60	133	0,6
50	66	151	0,6
60	80	171,5	1
70	92	198,5	1
80	105	232,5	1
90	115	264,5	1
100	130	296,5	1
110	140	334	1
120	160	391,5	1

Rod ends with a female thread, steel/bronze
d 5 – 30 mm

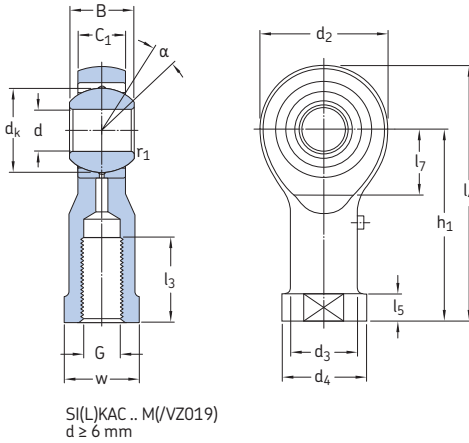

Principal dimensions				Angle of tilt		Basic load ratings		Mass	Designations		
d	d ₂ max	G 6H	B	C ₁ max	h ₁	α	C	C ₀		Rod end with right-hand thread	left-hand thread
mm						degrees	kN		kg	–	
5	19	M 5	8	7,5	27	13	3,25	5,4	0,017	SIKAC 5 M ¹⁾	SILKAC 5 M ¹⁾
	19	M 4	8	7,5	27	13	3,25	5,4	0,017	SIKAC 5 M/VZ019 ¹⁾	–
6	21	M 6	9	7,5	30	13	4,3	5,4	0,025	SIKAC 6 M	SILKAC 6 M
8	25	M 8	12	9,5	36	14	7,2	9,15	0,043	SIKAC 8 M	SILKAC 8 M
10	29	M 10	14	11,5	43	13	10	12,2	0,072	SIKAC 10 M	SILKAC 10 M
	29	M 10×1,25	14	11,5	43	13	10	12,2	0,072	SIKAC 10 M/VZ019	–
12	33	M 12	16	12,5	50	13	13,4	14	0,11	SIKAC 12 M	SILKAC 12 M
	33	M 12×1,25	16	12,5	50	13	13,4	14	0,11	SIKAC 12 M/VZ019	–
14	37	M 14	19	14,5	57	16	17	20,4	0,16	SIKAC 14 M	SILKAC 14 M
16	43	M 16	21	15,5	64	15	21,6	29	0,22	SIKAC 16 M	SILKAC 16 M
	43	M 16×1,5	21	15,5	64	15	21,6	29	0,22	SIKAC 16 M/VZ019	–
18	47	M 18×1,5	23	17,5	71	15	26	35,5	0,30	SIKAC 18 M	SILKAC 18 M
20	51	M 20×1,5	25	18,5	77	14	31,5	35,5	0,40	SIKAC 20 M	SILKAC 20 M
22	55	M 22×1,5	28	21	84	15	38	45	0,50	SIKAC 22 M	SILKAC 22 M
25	61	M 24×2	31	23	94	15	47,5	53	0,65	SIKAC 25 M	SILKAC 25 M
30	71	M 30×2	37	27	110	17	64	69,5	1,15	SIKAC 30 M	SILKAC 30 M
	71	M 27×2	37	27	110	17	64	69,5	1,15	SIKAC 30 M/VZ019	–

¹⁾No relubrication facilities.

Dimensions

d	d _k	d ₃ ≈	d ₄ max	l ₃ min	l ₄ max	l ₅ ≈	l ₇ min	r ₁ min	w h14
5	11,1 11,1	9 9	12 12	8 10	38 38	4 4	9 9	0,3 0,3	9 9
6	12,7	10	14	9	42	5	10	0,3	11
8	15,8	12,5	17	12	50	5	12	0,3	14
10	19 19	15 15	20 20	15 20	59 59	6,5 6,5	14 14	0,3 0,3	17 17
12	22,2 22,2	17,5 17,5	23 23	18 22	68 68	6,5 6,5	16 16	0,3 0,3	19 19
14	25,4	20	27	21	77	8	18	0,3	22
16	28,5 28,5	22 22	29 29	24 28	87 87	8 8	21 21	0,3 0,3	22 22
18	31,7	25	32	27	96	10	23	0,3	27
20	34,9	27,5	37	30	105	10	25	0,3	30
22	38,1	30	40	33	114	12	27	0,3	32
25	42,8	33,5	44	36	127	12	30	0,3	36
30	50,8 50,8	40 40	52 52	45 51	148 148	15 15	35 35	0,3 0,3	41 41

Rod ends with a male thread, steel/bronze
d 5 – 30 mm

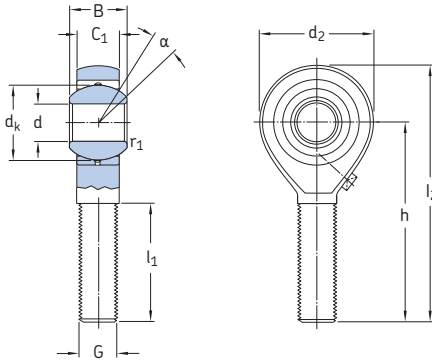

SA(L)KAC... M
d ≥ 6 mm

Principal dimensions						Angle of tilt	Basic load ratings		Mass	Designations	
d	d ₂ max	G 6g	B	C ₁ max	h	α	C	C ₀		Rod end with right-hand thread	left-hand thread
mm						degrees	kN		kg	–	
5	19	M 5	8	6	33	13	3,25	4,8	0,013	SAKAC 5 M ¹⁾	SALKAC 5 M ¹⁾
6	21	M 6	9	6,75	36	13	4,3	4,8	0,020	SAKAC 6 M	SALKAC 6 M
8	25	M 8	12	9	42	14	7,2	8	0,032	SAKAC 8 M	SALKAC 8 M
10	29	M 10	14	10,5	48	13	10	10,8	0,054	SAKAC 10 M	SALKAC 10 M
12	33	M 12	16	12	54	13	12,2	12,2	0,085	SAKAC 12 M	SALKAC 12 M
14	37	M 14	19	13,5	60	16	17	17,3	0,13	SAKAC 14 M	SALKAC 14 M
16	43	M 16	21	15	66	16	21,6	23,2	0,19	SAKAC 16 M	SALKAC 16 M
18	47	M 18×1,5	23	16,5	72	16	26	29	0,26	SAKAC 18 M	SALKAC 18 M
20	51	M 20×1,5	25	18	78	16	29	29	0,34	SAKAC 20 M	SALKAC 20 M
22	55	M 22×1,5	28	20	84	16	38	39	0,44	SAKAC 22 M	SALKAC 22 M
25	61	M 24×2	31	22	94	15	46,5	46,5	0,60	SAKAC 25 M	SALKAC 25 M
30	71	M 30×2	37	25	110	17	61	61	1,05	SAKAC 30 M	SALKAC 30 M

¹⁾No relubrication facilities.

Dimensions

d	d _k	l ₁ min	l ₂ max	r ₁ min
---	----------------	-----------------------	-----------------------	-----------------------

mm

5	11,1	19	44	0,3
6	12,7	21	48	0,3
8	15,8	25	56	0,3
10	19	28	64	0,3
12	22,2	32	72	0,3
14	25,4	36	80	0,3
16	28,5	37	89	0,3
18	31,7	41	97	0,3
20	34,9	45	106	0,3
22	38,1	48	114	0,3
25	42,8	55	127	0,3
30	50,8	66	148	0,3



Maintenance-free rod ends

Dimensions	190
Tolerances	191
Radial internal clearance, preload	191
Materials	192
Permissible operating temperature range	192
Fatigue strength	192
Product tables	194
7.1 Maintenance-free rod ends with a female thread, steel/PTFE sintered bronze	194
7.2 Maintenance-free rod ends with a male thread, steel/PTFE sintered bronze.....	196
7.3 Maintenance-free rod ends with a female thread, steel/PTFE fabric	198
7.4 Maintenance-free rod ends with a male thread, steel/PTFE fabric	200
7.5 Maintenance-free rod ends with a female thread, steel/PTFE FRP.....	202
7.6 Maintenance-free rod ends with a male thread, steel/PTFE FRP.....	204

Maintenance-free rod ends

SKF manufactures maintenance-free rod ends with three different sliding contact surface combinations in different series:

- Steel/PTFE sintered bronze (→ **fig. 1**):
 - SI(L) .. C series
 - SA(L) .. C series
- Steel/PTFE fabric (→ **fig. 2**):
 - SI(L) .. TXE-2LS series
 - SI(L)A .. TXE-2LS series
 - SA(L) .. TXE-2LS series
 - SA(L)A .. TXE-2LS series
- Steel/PTFE FRP (→ **fig. 3**):
 - SI(L)KB .. F series
 - SA(L)KB .. F series

Rod ends with either a steel/PTFE sintered bronze or steel/PTFE fabric sliding contact surface combination contain a bearing from the standard assortment. The outer ring is staked in place in the housing.

Rod ends with a steel/PTFE FRP sliding contact surface combination consist of a rod end housing and a spherical plain bearing inner ring. Between the housing and the inner ring, a sliding layer of fibre reinforced polymer, containing PTFE, is moulded to the housing.

SKF supplies maintenance-free rod ends with a threaded shank with a right-hand thread as standard. With the exception of rod ends with the designation suffix VZ019, all rod ends are also available with a left-hand thread. They are identified by the designation prefix L.

Dimensions

The dimensions of SKF maintenance-free rod ends are in accordance with ISO 12240-4:1998.

Male and female threads of SKF rod ends are in accordance with ISO 965-1:1998, except for rod ends with female thread having the designation suffix /VZ019, which is in accordance with ISO 8139:2009.

Fig. 1

Maintenance-free rod end, steel/PTFE sintered bronze

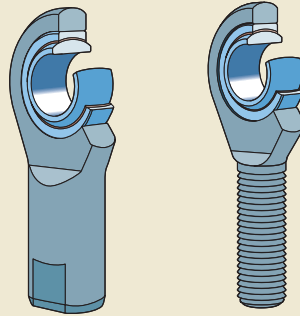

Fig. 2

Maintenance-free rod end, steel/PTFE fabric

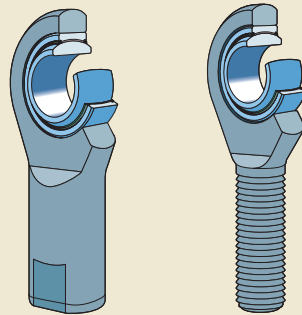
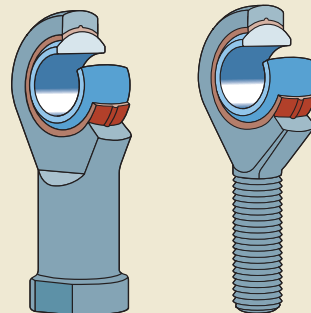

Fig. 3

Maintenance-free rod end, steel/PTFE FRP



Tolerances

SKF rod end inner ring dimensional tolerances are in accordance with ISO 12240-1:1998. The tolerances are listed in **table 1**.

The symbols used in **table 1** are explained in the following:

- d nominal bore diameter
- Δ_{dmp} deviation of the mean bore diameter from the nominal
- Δ_{Bs} deviation of the single inner ring width from the nominal

Radial internal clearance, preload

Depending on their design, SKF maintenance-free rod ends may have a radial internal clearance or a light preload. **Table 2** lists maximum values for the radial internal clearance as well as for the frictional moment in the circumferential direction caused by preload.

Table 2

Radial internal clearance and frictional moment for maintenance-free rod ends

Bore diameter d		Radial internal clearance	Frictional moment
over	incl.	max	max
mm		μm	Nm

Sliding surface steel/PTFE sintered bronze (designation suffix C)

–	12	28	0,15
12	20	35	0,25
20	30	44	0,40

Sliding surface steel/PTFE fabric (designation suffix TXE-2LS)

35	80	50	–
-----------	-----------	----	---

Sliding surface steel/PTFE FRP (designation suffix F)

5		50	0,20
6		50	0,25
8		50	0,30
10		75	0,40
12		75	0,50
14		75	0,60
16		75	0,70
18		85	0,80
20		100	1
22		100	1,2

Table 1

Inner ring dimensional tolerances for maintenance-free rod ends

Bore diameter d		SA(A) and SI(A) series				SAKB and SIKB series			
over	incl.	Δ_{dmp}		Δ_{Bs}		Δ_{dmp}		Δ_{Bs}	
		high	low	high	low	high	low	high	low
mm		μm		μm		μm		μm	
–	6	0	–8	0	–120	12	0	0	–120
6	10	0	–8	0	–120	15	0	0	–120
10	18	0	–8	0	–120	18	0	0	–120
18	30	0	–10	0	–120	21	0	0	–120
30	50	0	–12	0	–120	–	–	–	–
50	80	0	–15	0	–150	–	–	–	–

Maintenance-free rod ends

Materials

SKF rod end housings for maintenance-free bearings are made of materials as listed in **table 3**.

Details of the materials used for the maintenance-free radial spherical plain bearings incorporated in the rod ends are listed in **table 3** on **pages 128 to 129**.

The inner ring of rod ends with a steel/PTFE FRP sliding contact surface combination is made of bearing steel. The ring is through-hardened and ground. The sliding contact surface of the inner ring is hard chromium plated. The sliding layer consists of a fibre reinforced polymer, containing PTFE.

Permissible operating temperature range

The permissible operating temperature range for SKF maintenance-free rod ends depends on the rod end housing, the incorporated bearing and the bearing seals. The values for the permissible operating temperature range are listed in **table 4**.

The load carrying capacity of the rod end is reduced at temperatures above 100 °C. For temperatures below 0 °C, check to be sure that the fracture toughness of the rod end housing is adequate for the intended application.

Fatigue strength

In all applications where a rod end is subjected to alternating loads, loads that vary in magnitude or where failure of a rod end is dangerous, make sure that the selected rod end has sufficient fatigue strength.

Table 3

Housing materials for maintenance-free rod ends

Series	Size	Material	Material No.
SA(A) SI(A)	6 to 80	Heat treatable steel C45V, zinc coated and chromitized	1.0503
SAKB SIKB	5 to 12	Free-machining steel, zinc coated and chromitized	1.0718
	14 to 22	Heat treatable steel C35N, zinc coated and chromitized	1.0501

Table 4

Permissible operating temperature range for maintenance-free rod ends

Rod end sliding contact surface combination	Permissible operating temperature range ¹⁾		Reduced load carrying capacity
	from	incl.	
–	°C		°C
Steel/PTFE sintered bronze	–50	+150	+80
Steel/PTFE fabric	–40	+110	+65
Steel/PTFE FRP	–40	+75	+50

¹⁾ For temperatures below 0 °C, make sure that the fracture toughness of the rod end housing is adequate for the intended application.

Maintenance-free rod ends with a female thread, steel/PTFE sintered bronze
d 6 – 30 mm

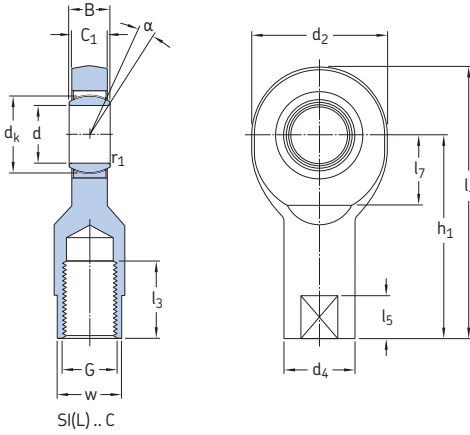

Principal dimensions						Angle of tilt	Basic load ratings		Mass	Designations	
d	d ₂ max	G 6H	B	C ₁ max	h ₁	α	C	C ₀		Rod end with right-hand thread	left-hand thread
mm						degrees	kN		kg	–	
6	22	M 6	6	4,5	30	13	3,6	8,15	0,023	SI 6 C	SIL 6 C
8	25	M 8	8	6,5	36	15	5,8	12,9	0,036	SI 8 C	SIL 8 C
10	30	M 10	9	7,5	43	12	8,65	19	0,065	SI 10 C	SIL 10 C
12	35	M 12	10	8,5	50	10	11,4	25,5	0,11	SI 12 C	SIL 12 C
15	41	M 14	12	10,5	61	8	18	37,5	0,18	SI 15 C	SIL 15 C
17	47	M 16	14	11,5	67	10	22,4	46,5	0,25	SI 17 C	SIL 17 C
20	54	M 20×1,5	16	13,5	77	9	31,5	57	0,35	SI 20 C	SIL 20 C
25	65	M 24×2	20	18	94	7	51	90	0,65	SI 25 C	SIL 25 C
30	75	M 30×2	22	20	110	6	65,5	118	1,05	SI 30 C	SIL 30 C

Dimensions

d	d _k	d ₄ ≈	l ₃ min	l ₄ max	l ₅ ≈	l ₇ min	r ₁ min	w h14
mm								
6	10	11	11	43	8	10	0,3	9
8	13	13	15	50	9	11	0,3	11
10	16	16	15	60	11	13	0,3	14
12	18	19	18	69	12	17	0,3	17
15	22	22	21	83	14	19	0,3	19
17	25	25	24	92	15	22	0,3	22
20	29	28	30	106	16	24	0,3	24
25	35,5	35	36	128	18	30	0,6	30
30	40,7	42	45	149	19	34	0,6	36

Maintenance-free rod ends with a male thread, steel/PTFE sintered bronze
d 6 – 30 mm

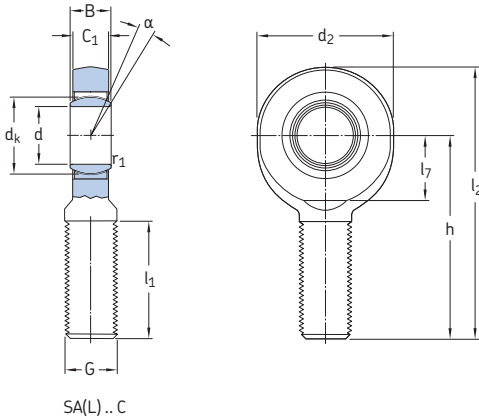

Principal dimensions						Angle of tilt	Basic load ratings		Mass	Designations	
d	d ₂ max	G 6g	B	C ₁ max	h	α	C	C ₀		Rod end with right-hand thread	left-hand thread
mm						degrees	kN		kg	–	
6	22	M 6	6	4,5	36	13	3,6	8,15	0,017	SA 6 C	SAL 6 C
8	25	M 8	8	6,5	42	15	5,85	12,9	0,030	SA 8 C	SAL 8 C
10	30	M 10	9	7,5	48	12	8,65	18,3	0,053	SA 10 C	SAL 10 C
12	35	M 12	10	8,5	54	10	11,4	24,5	0,078	SA 12 C	SAL 12 C
15	41	M 14	12	10,5	63	8	18	34,5	0,13	SA 15 C	SAL 15 C
17	47	M 16	14	11,5	69	10	22,4	42,5	0,19	SA 17 C	SAL 17 C
20	54	M 20×1,5	16	13,5	78	9	31,5	51	0,32	SA 20 C	SAL 20 C
25	65	M 24×2	20	18	94	7	51	78	0,57	SA 25 C	SAL 25 C
30	75	M 30×2	22	20	110	6	65,5	104	0,90	SA 30 C	SAL 30 C

Dimensions

d	d _k	l ₁ min	l ₂ max	l ₇ min	r ₁ min
mm					
6	10	16	49	10	0,3
8	13	21	56	11	0,3
10	16	26	65	13	0,3
12	18	28	73	17	0,3
15	22	34	85	19	0,3
17	25	36	94	22	0,3
20	29	43	107	24	0,3
25	35,5	53	128	30	0,6
30	40,7	65	149	34	0,6

Maintenance-free rod ends with a female thread, steel/PTFE fabric
d 35 – 80 mm

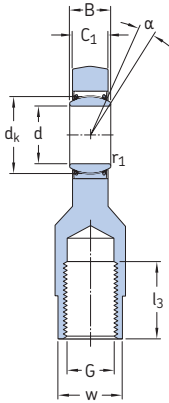

SI(L)..TXE-2LS

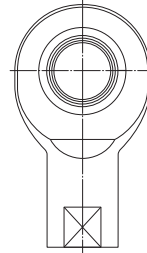
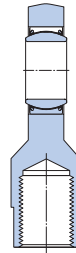
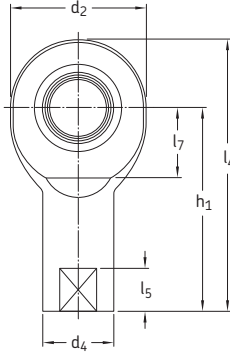

SI(LA)..TXE-2LS

Principal dimensions					Angle of tilt α	Basic load ratings ¹⁾		Mass	Designations Rod end with right-hand thread	left-hand thread	
d	d ₂ max	G 6H	B	C ₁ max		h ₁	C				C ₀
mm						degrees	kN	kg	–		
35	84	M 36×3	25	22	130	6	224	134	1,40	SI 35 TXE-2LS	SIL 35 TXE-2LS
	94	M 39×3	28	24	142	7	280	166	2,20	SIA 40 TXE-2LS	SILA 40 TXE-2LS
40	94	M 42×3	28	24	145	7	280	166	2,30	SI 40 TXE-2LS	SIL 40 TXE-2LS
	104	M 45×3	32	28	165	7	360	224	2,90	SIA 45 TXE-2LS	SILA 45 TXE-2LS
45	104	M 45×3	32	28	165	7	360	224	3,20	SI 45 TXE-2LS	SIL 45 TXE-2LS
	114	M 45×3	35	31	160	6	440	270	4,10	SIA 50 TXE-2LS	SILA 50 TXE-2LS
50	114	M 52×3	35	31	195	6	440	270	4,50	SI 50 TXE-2LS	SIL 50 TXE-2LS
	137	M 52×3	44	39	175	6	695	400	6,30	SIA 60 TXE-2LS	SILA 60 TXE-2LS
60	137	M 60×4	44	39	225	6	695	400	7,10	SI 60 TXE-2LS	SIL 60 TXE-2LS
	162	M 72×4	49	43	265	6	880	530	10,5	SI 70 TXE-2LS	SIL 70 TXE-2LS
70	162	M 72×4	49	43	265	6	880	530	10,5	SI 70 TXE-2LS	SIL 70 TXE-2LS
80	182	M 80×4	55	48	295	5	1 140	655	19,0	SI 80 TXE-2LS	SIL 80 TXE-2LS

¹⁾ Dynamic load rating of the bearing to be used for basic rating life calculation only. Check suitability of the rod end against its static load rating in all cases. The dynamic load applied on the rod end must not exceed its static load rating.

Dimensions

d	d _k	d ₄ ≈	l ₃ min	l ₄ max	l ₅ ≈	l ₇ min	r ₁ min	w h14
35	47	49	60	174	25	40	0,6	41
40	53 53	58 58	65 65	191 194	25 25	46 46	0,6 0,6	50 50
45	60 60	65 65	65 65	199 219	30 30	50 50	0,6 0,6	55 55
50	66 66	70 70	68 68	219 254	30 30	58 58	0,6 0,6	60 60
60	80 80	82 82	70 70	246 296	35 35	73 73	1 1	70 70
70	92	92	80	349	40	85	1	80
80	105	105	85	389	40	98	1	90

Maintenance-free rod ends with a male thread, steel/PTFE fabric
d 35 – 80 mm

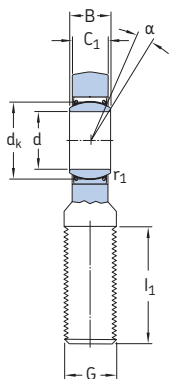

SA(L)..TXE-2LS

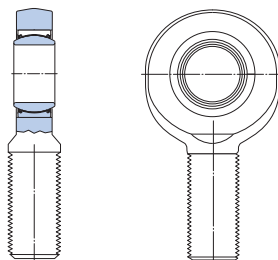
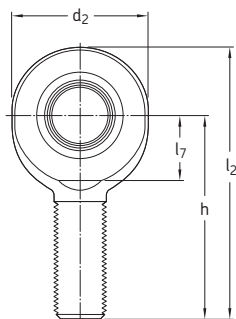

SA(L)A..TXE-2LS

Principal dimensions						Angle of tilt	Basic load ratings ¹⁾		Mass	Designations	
d	d ₂ max	G 6g	B	C ₁ max	h	α	C	C ₀		Rod end with right-hand thread	left-hand thread
mm						degrees	kN		kg	–	
35	84	M 36×3	25	22	130	6	224	110	1,30	SA 35 TXE-2LS	SAL 35 TXE-2LS
40	94	M 39×3	28	24	150	6	280	140	1,85	SAA 40 TXE-2LS	SALA 40 TXE-2LS
	94	M 42×3	28	24	145	6	280	140	1,90	SA 40 TXE-2LS	SAL 40 TXE-2LS
45	104	M 42×3	32	28	163	7	360	200	2,45	SAA 45 TXE-2LS	SALA 45 TXE-2LS
	104	M 45×3	32	28	165	7	360	200	2,55	SA 45 TXE-2LS	SAL 45 TXE-2LS
50	114	M 45×3	35	31	185	6	440	245	3,30	SAA 50 TXE-2LS	SALA 50 TXE-2LS
	114	M 52×3	35	31	195	6	440	245	3,90	SA 50 TXE-2LS	SAL 50 TXE-2LS
60	137	M 52×3	44	39	210	6	695	360	5,70	SAA 60 TXE-2LS	SALA 60 TXE-2LS
	137	M 60×4	44	39	225	6	695	360	6,25	SA 60 TXE-2LS	SAL 60 TXE-2LS
70	162	M 72×4	49	43	265	6	880	490	10,0	SA 70 TXE-2LS	SAL 70 TXE-2LS
80	182	M 80×4	55	48	295	5	1 140	585	14,5	SA 80 TXE-2LS	SAL 80 TXE-2LS

¹⁾ Dynamic load rating of the bearing to be used for basic rating life calculation only. Check suitability of the rod end against its static load rating in all cases. The dynamic load applied on the rod end must not exceed its static load rating.

Dimensions

d	d _k	l ₁ min	l ₂ max	l ₇ min	r ₁ min
mm					
35	47	82	174	40	0,6
40	53 53	86 90	199 194	46 46	0,6 0,6
45	60 60	92 95	217 219	50 50	0,6 0,6
50	66 66	104 110	244 254	58 58	0,6 0,6
60	80 80	115 120	281 296	73 73	1 1
70	92	132	349	85	1
80	105	147	389	98	1

Maintenance-free rod ends with a female thread, steel/PTFE FRP
d 5 – 22 mm

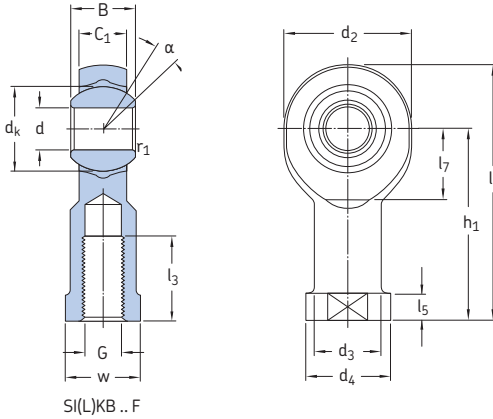

Principal dimensions						Angle of tilt	Basic load ratings		Mass	Designations	
d	d ₂ max	G 6H	B	C ₁ max	h ₁	α	C	C ₀		Rod end with right-hand thread	left-hand thread
mm						degrees	kN		kg	–	
5	19	M 5	8	6	27	13	3,25	5,3	0,019	SIKB 5 F	SILKB 5 F
6	21	M 6	9	6,75	30	13	4,25	6,8	0,028	SIKB 6 F	SILKB 6 F
8	25	M 8	12	9	36	14	7,1	11,4	0,047	SIKB 8 F	SILKB 8 F
10	29	M 10	14	10,5	43	13	9,8	14,3	0,079	SIKB 10 F	SILKB 10 F
	29	M 10×1,25	14	10,5	43	13	9,8	14,3	0,079	SIKB 10 F/VZ019	–
12	33	M 12	16	12	50	13	13,2	17	0,12	SIKB 12 F	SILKB 12 F
	33	M 12×1,25	16	12	50	13	13,2	17	0,12	SIKB 12 F/VZ019	–
14	37	M 14	19	13,5	57	16	17	27,5	0,16	SIKB 14 F	SILKB 14 F
16	43	M 16	21	15	64	15	21,4	34,5	0,23	SIKB 16 F	SILKB 16 F
	43	M 16×1,5	21	15	64	15	21,4	34,5	0,23	SIKB 16 F/VZ019	–
18	47	M 18×1,5	23	16,5	71	15	26	41,5	0,33	SIKB 18 F	SILKB 18 F
20	51	M 20×1,5	25	18	77	14	31	50	0,38	SIKB 20 F	SILKB 20 F
22	55	M 22×1,5	28	20	84	15	38	61	0,52	SIKB 22 F	SILKB 22 F

Dimensions

d	d _k	d ₃ ≈	d ₄ max	l ₃ min	l ₄ max	l ₅ ≈	l ₇ min	r ₁ min	w h14
mm									
5	11,1	9	12	8	37	4	9	0,3	9
6	12,7	10	14	9	41	5	10	0,3	11
8	15,8	12,5	17	12	49	5	12	0,3	14
10	19	15	20	15	58	6,5	14	0,3	17
	19	15	20	20	58	6,5	14	0,3	17
12	22,2	17,5	23	18	67	6,5	16	0,3	19
	22,2	17,5	23	22	67	6,5	16	0,3	19
14	25,4	20	27	21	76	8	18	0,3	22
16	28,5	22	29	24	86	8	21	0,3	22
	28,5	22	29	28	86	8	21	0,3	22
18	31,7	25	32	27	95	10	23	0,3	27
20	34,9	27,5	37	30	103	10	25	0,3	30
22	38,1	30	40	33	114	12	27	0,3	32

Maintenance-free rod ends with a male thread, steel/PTFE FRP
d 5 – 22 mm

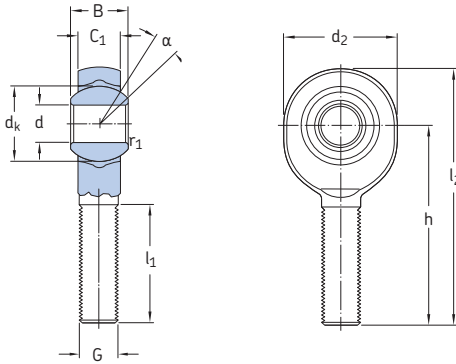

SA(L)KB ..F

Principal dimensions						Angle of tilt	Basic load ratings		Mass	Designations	
d	d ₂ max	G 6g	B	C ₁ max	h	α	C	C ₀		Rod end with right-hand thread	left-hand thread
mm						degrees	kN		kg	–	
5	19	M 5	8	6	33	13	3,25	5,3	0,015	SAKB 5 F	SALKB 5 F
6	21	M 6	9	6,75	36	13	4,25	6,8	0,021	SAKB 6 F	SALKB 6 F
8	25	M 8	12	9	42	14	7,1	10	0,035	SAKB 8 F	SALKB 8 F
10	29	M 10	14	10,5	48	13	9,8	12,5	0,059	SAKB 10 F	SALKB 10 F
12	33	M 12	16	12	54	13	13,2	15	0,10	SAKB 12 F	SALKB 12 F
14	37	M 14	19	13,5	60	16	17	25,5	0,13	SAKB 14 F	SALKB 14 F
16	43	M 16	21	15	66	15	21,4	34,5	0,20	SAKB 16 F	SALKB 16 F
18	47	M 18×1,5	23	16,5	72	15	26	41,5	0,26	SAKB 18 F	SALKB 18 F
20	51	M 20×1,5	25	18	78	14	31	50	0,37	SAKB 20 F	SALKB 20 F
22	55	M 22×1,5	28	20	84	15	38	58,5	0,46	SAKB 22 F	SALKB 22 F

Dimensions

d	d _k	l ₁ min	l ₂ max	r ₁ min
---	----------------	-----------------------	-----------------------	-----------------------

mm

5	11,1	19	44	0,3
6	12,7	21	48	0,3
8	15,8	25	56	0,3
10	19	28	64	0,3
12	22,2	32	72	0,3
14	25,4	36	80	0,3
16	28,5	37	89	0,3
18	31,7	41	97	0,3
20	34,9	45	106	0,3
22	38,1	48	114	0,3



Other SKF plain bearings and special solutions

Spherical plain bearings for road vehicles.....	208
Plain bearings for railway vehicles	208
Bushing units for off highway vehicles	208
Spherical plain bearings and rod ends for the aircraft industry.....	209
Bushings, thrust washers and strips	209
Rod ends for the food industry	210

Other SKF plain bearings and special solutions

Spherical plain bearings for road vehicles

SKF spherical plain bearings or bearing units are also available for special applications. Therefore, SKF works closely with the customer to develop customized products, e.g. solutions for centring propeller shafts or gear shifts.



Plain bearings for railway vehicles

The SKF assortment of plain bearings for railway vehicles includes bogie swivel bearings for trams and heavy-duty goods wagons as well as spherical plain bearings and rod ends for transverse stabilizers, tilting mechanisms etc.



Bushing units for off-highway vehicles

Many off-highway vehicles have bushings made of steel or bronze that require relubrication. SKF has developed state-of-the-art bushing units with seals. As these units do not require grease, costs are reduced and productivity is increased.

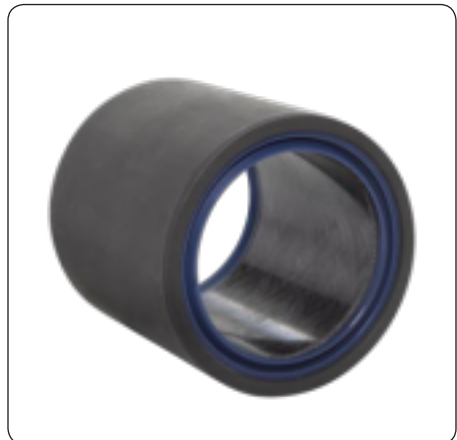

Spherical plain bearings and rod ends for the aircraft industry

SKF supplies a wide assortment of special spherical plain bearings and rod ends in various designs and materials for aerospace applications worldwide. The main applications are air-frame bearings for the transmission of rotating, tilting and oscillating movements as used in undercarriages, spoilers, height and side rudders, wing flaps etc.



Bushings, thrust washers and strips

SKF offers a wide assortment of bushings available from stock. Bushings are suitable for rotating, oscillating and linear movements and are available as cylindrical or flanged designs. Thrust washers are intended for applications where axial space is limited, maintenance is not possible and where lubricant starvation can occur.

SKF also supplies strips made of the same materials as thrust washers. They can be bent, pressed or coined to form flat linear guides, e.g. L-shaped or V-shaped profiles, or other types of dry sliding components.

Different materials meet different requirements:

- solid bronze, the traditional robust material
- sintered bronze with oil impregnation, for high sliding velocities
- wrapped bronze with lubrication pockets, for contaminated environments
- PTFE composite with reduced friction, for long service life
- POM composite, for minimal maintenance under arduous conditions
- PTFE polyamide, cost-effective and maintenance-free
- filament wound, for extreme conditions

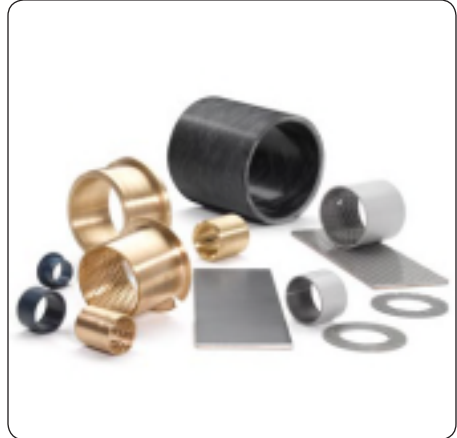

Rod ends for the food industry

The food and beverage processing industries have unique requirements. Depending on the application, equipment has to withstand the following influences:

- hot, cold or wet environments
- frequent wash downs
- exposure to harsh cleaning agents
- food and liquid contaminants
- a variety of chemicals

To deal with these challenging operating conditions, SKF offers rod ends with a stainless steel housing or with a composite housing. Both series are equipped with a stainless steel inner ring and an injection moulded PTFE FRP dry sliding layer. The used materials provide the following properties:

- corrosion resistant
- good wear resistance
- low friction
- cost-effective





Product index

Designation	Product	Product table	Page
GAC .. F	Maintenance-free angular contact spherical plain bearings, steel/PTFE FRP	4.1	156
GE .. C	Maintenance-free radial spherical plain bearings, steel/PTFE sintered bronze, metric sizes	3.1	132
GE .. CJ2	Maintenance-free radial spherical plain bearings, steel/PTFE sintered bronze, metric sizes	3.1	132
GE .. E	Radial spherical plain bearings requiring maintenance, steel/steel, metric sizes	2.1	104
GE .. ES	Radial spherical plain bearings requiring maintenance, steel/steel, metric sizes	2.1	104
GE .. ES-2LS	Radial spherical plain bearings requiring maintenance, steel/steel, metric sizes	2.1	104
GE .. ES-2RS	Radial spherical plain bearings requiring maintenance, steel/steel, metric sizes	2.1	104
GE .. TXA-2LS	Maintenance-free radial spherical plain bearings, steel/PTFE fabric, metric sizes	3.2	134
GE .. TXE-2LS	Maintenance-free radial spherical plain bearings, steel/PTFE fabric, metric sizes	3.2	134
GE .. TXG3A-2LS	Maintenance-free radial spherical plain bearings, steel/PTFE fabric, metric sizes	3.2	134
GE .. TXG3E-2LS	Maintenance-free radial spherical plain bearings, steel/PTFE fabric, metric sizes	3.2	134
GE .. TXGR	Maintenance-free radial spherical plain bearings, steel/PTFE fabric, metric sizes	3.2	134
GEC .. FBAS	Maintenance-free radial spherical plain bearings, steel/PTFE FRP, metric sizes	3.4	144
GEC .. TXA-2RS	Maintenance-free radial spherical plain bearings, steel/PTFE fabric, metric sizes	3.2	134
GEG .. ES	Radial spherical plain bearings requiring maintenance, steel/steel, with an extended inner ring, metric sizes	2.3	116
GEG .. ESA	Radial spherical plain bearings requiring maintenance, steel/steel, with an extended inner ring, metric sizes	2.3	116
GEH .. C	Maintenance-free radial spherical plain bearings, steel/PTFE sintered bronze, metric sizes	3.1	132
GEH .. ES-2LS	Radial spherical plain bearings requiring maintenance, steel/steel, metric sizes	2.1	104
GEH .. ES-2RS	Radial spherical plain bearings requiring maintenance, steel/steel, metric sizes	2.1	104
GEH .. TXA-2LS	Maintenance-free radial spherical plain bearings, steel/PTFE fabric, metric sizes	3.2	134
GEH .. TXE-2LS	Maintenance-free radial spherical plain bearings, steel/PTFE fabric, metric sizes	3.2	134
GEH .. TXG3A-2LS	Maintenance-free radial spherical plain bearings, steel/PTFE fabric, metric sizes	3.2	134
GEH .. TXG3E-2LS	Maintenance-free radial spherical plain bearings, steel/PTFE fabric, metric sizes	3.2	134
GEM .. ES-2LS	Radial spherical plain bearings requiring maintenance, steel/steel, with an extended inner ring, metric sizes	2.3	116
GEM .. ES-2RS	Radial spherical plain bearings requiring maintenance, steel/steel, with an extended inner ring, metric sizes	2.3	116
GEP .. FS	Maintenance-free radial spherical plain bearings, steel/PTFE FRP, metric sizes	3.4	144
GEZ .. ES	Radial spherical plain bearings requiring maintenance, steel/steel, inch sizes	2.2	110
GEZ .. ES-2LS	Radial spherical plain bearings requiring maintenance, steel/steel, inch sizes	2.2	110
GEZ .. ES-2RS	Radial spherical plain bearings requiring maintenance, steel/steel, inch sizes	2.2	110
GEZ .. TXA-2LS	Maintenance-free radial spherical plain bearings, steel/PTFE fabric, inch sizes	3.3	140
GEZ .. TXE-2LS	Maintenance-free radial spherical plain bearings, steel/PTFE fabric, inch sizes	3.3	140
GEZH .. ES	Radial spherical plain bearings requiring maintenance, steel/steel, inch sizes	2.2	110
GEZH .. ES-2LS	Radial spherical plain bearings requiring maintenance, steel/steel, inch sizes	2.2	110
GEZH .. ES-2RS	Radial spherical plain bearings requiring maintenance, steel/steel, inch sizes	2.2	110
GEZM .. ES	Radial spherical plain bearings requiring maintenance, steel/steel, with an extended inner ring, inch sizes	2.4	120
GEZM .. ES-2LS	Radial spherical plain bearings requiring maintenance, steel/steel, with an extended inner ring, inch sizes	2.4	120
GEZM .. ES-2RS	Radial spherical plain bearings requiring maintenance, steel/steel, with an extended inner ring, inch sizes	2.4	120
GX .. F	Maintenance-free thrust spherical plain bearings, steel/PTFE FRP	5.1	164
SA .. C	Maintenance-free rod ends, male thread, steel/PTFE sintered bronze	7.2	196
SA .. E	Rod ends requiring maintenance, male thread, steel/steel	6.3	178
SA .. ES	Rod ends requiring maintenance, male thread, steel/steel	6.3	178
SA .. ES-2RS	Rod ends requiring maintenance, male thread, steel/steel	6.3	178
SA .. TXE-2LS	Maintenance-free rod ends, male thread, steel/PTFE fabric	7.4	200
SAA .. ES-2RS	Rod ends requiring maintenance, male thread, steel/steel	6.3	178
SAA .. TXE-2LS	Maintenance-free rod ends, male thread, steel/PTFE fabric	7.4	200
SAKAC .. M	Rod ends requiring maintenance, male thread, steel/bronze	6.7	186
SAKB .. F	Maintenance-free rod ends, male thread, steel/PTFE FRP	7.6	204
SAL .. C	Maintenance-free rod ends, male thread, steel/PTFE sintered bronze	7.2	196
SAL .. E	Rod ends requiring maintenance, male thread, steel/steel	6.3	178

Product index

Designation	Product	Product table	Page
SAL .. ES	Rod ends requiring maintenance, male thread, steel/steel	6.3	178
SAL .. ES-2RS	Rod ends requiring maintenance, male thread, steel/steel	6.3	178
SAL .. TXE-2LS	Maintenance-free rod ends, male thread, steel/PTFE fabric	7.4	200
SALA .. ES-2RS	Rod ends requiring maintenance, male thread, steel/steel	6.3	178
SALA .. TXE-2LS	Maintenance-free rod ends, male thread, steel/PTFE fabric	7.4	200
SALKAC .. M	Rod ends requiring maintenance, male thread, steel/bronze	6.7	186
SALKB .. F	Maintenance-free rod ends, male thread, steel/PTFE FRP	7.6	204
SC .. ES	Rod ends requiring maintenance, cylindrical section welding shank, steel/steel	6.4	180
SCF .. ES	Rod ends requiring maintenance, rectangular section welding shank, steel/steel	6.5	182
SI .. C	Maintenance-free rod ends, female thread, steel/PTFE sintered bronze	7.1	194
SI .. E	Rod ends requiring maintenance, female thread, steel/steel	6.1	172
SI .. ES	Rod ends requiring maintenance, female thread, steel/steel	6.1	172
SI .. ES-2RS	Rod ends requiring maintenance, female thread, steel/steel	6.1	172
SI .. TXE-2LS	Maintenance-free rod ends, female thread, steel/PTFE fabric	7.3	198
SIA .. ES-2RS	Rod ends requiring maintenance, female thread, steel/steel	6.1	172
SIA .. TXE-2LS	Maintenance-free rod ends, female thread, steel/PTFE fabric	7.3	198
SIJ .. E	Rod ends requiring maintenance for hydraulic cylinders, female thread, steel/steel	6.2	174
SIJ .. ES	Rod ends requiring maintenance for hydraulic cylinders, female thread, steel/steel	6.2	174
SIKAC .. M	Rod ends requiring maintenance, female thread, steel/bronze	6.6	184
SIKAC .. M/VZ019	Rod ends requiring maintenance, female thread, steel/bronze, thread differs from standard	6.6	184
SIKB .. F	Maintenance-free rod ends, female thread, steel/PTFE FRP	7.5	202
SIKB .. F/VZ019	Maintenance-free rod ends, female thread, steel/PTFE FRP, thread differs from standard	7.5	202
SIL .. C	Maintenance-free rod ends, female thread, steel/PTFE sintered bronze	7.1	194
SIL .. E	Rod ends requiring maintenance, female thread, steel/steel	6.1	172
SIL .. ES	Rod ends requiring maintenance, female thread, steel/steel	6.1	172
SIL .. ES-2RS	Rod ends requiring maintenance, female thread, steel/steel	6.1	172
SIL .. TXE-2LS	Maintenance-free rod ends, female thread, steel/PTFE fabric	7.3	198
SILA .. ES-2RS	Rod ends requiring maintenance, female thread, steel/steel	6.1	172
SILA .. TXE-2LS	Maintenance-free rod ends, female thread, steel/PTFE fabric	7.3	198
SILJ .. E	Rod ends requiring maintenance for hydraulic cylinders, female thread, steel/steel	6.2	174
SILJ .. ES	Rod ends requiring maintenance for hydraulic cylinders, female thread, steel/steel	6.2	174
SILKAC .. M	Rod ends requiring maintenance, female thread, steel/bronze	6.6	184
SILKB .. F	Maintenance-free rod ends, female thread, steel/PTFE FRP	7.5	202
SILQG .. ES	Rod ends requiring maintenance for hydraulic cylinders, female thread, steel/steel	6.2	174
SILQG .. ESA	Rod ends requiring maintenance for hydraulic cylinders, female thread, steel/steel	6.2	174
SILR .. ES	Rod ends requiring maintenance for hydraulic cylinders, female thread, steel/steel	6.2	174
SIQG .. ES	Rod ends requiring maintenance for hydraulic cylinders, female thread, steel/steel	6.2	174
SIQG .. ESA	Rod ends requiring maintenance for hydraulic cylinders, female thread, steel/steel	6.2	174
SIR .. ES	Rod ends requiring maintenance for hydraulic cylinders, female thread, steel/steel	6.2	174

